

N17

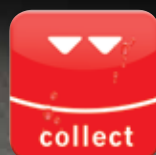

collect: zbiranje

# Xtradrain

Xtradrain X100	6
Xtradrain X150	13
Xtradrain X200	18



## ACO Xtradrain

### – kanalete iz umetne mase za profesionalno uporabo



Enostavno rokovanje, premišljeni detajli in najvišja kvaliteta izdelave so glavni aduti nove ACO kanalete Xtradrain, ki je zaradi izvirne izvedbe nekaterih detajlov (kot npr. izvedba križnih, kotnih in T povezav brez posebnega orodja, ipd.) še posebej primerna za odvodnjavanje in oblikovanje arhitektonsko zahtevnejši površin.

#### Področja uporabe

- Področja za pešce in kolesarje
- Dovozi na dvorišča in v garaže
- Javni in zasebni parkirni prostori za osebna vozila
- Teras
- Dvorišča

**Kanalete Xtradrain** so izdelane iz kompozitnih materialov (recikliran polipropilen visoke gostote) z odličnimi statičnimi lastnostmi.

Na razpolago so svetle širine 100 mm (H= 75 mm in 150 mm), 150 mm (H= 210 mm) in 200 mm (H= 265 mm). Kanalete so na razpolago z robom iz umetne mase ali robom iz vročecinkane pločevine. Uporabljajo se lahko pokrivne rešetke iz programa Multiline od tradicionalnih litoželeznih in pokravnih rešetk iz vročecinkanega jekla do nerjavečih in rešetk iz kompozitnih materialov, vse za razrede obremenitve A15 do D400 kN.

#### Hex RibTechnology™

Zaradi Hex Rib tehnologije je vgradnja kanalet trajnejša in zaneslivejša. Utori in peresa za sidranje zagotavljajo popoln spoj med kanaletjo in betonom.

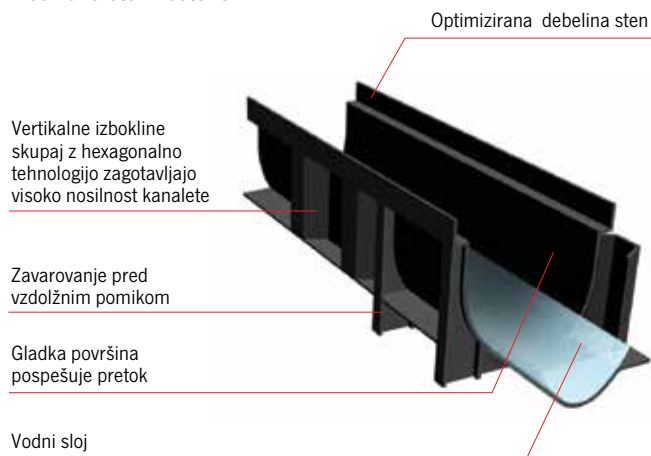

ACO Xtradrain Eyeleds ni samo kanaleta za odvodnjavanje površinskih vod, temveč istočasno tudi napredna in estetsko dovršena rešitev za osvetlitev dvorišča, dovozne poti, ipd., z v kompozitno pokrivno rešetko vstavljenimi LED svetili. Več o tem lahko najdete v katalogu ACO Eyeleds.





Kanalete ACO Xtradrain - lahko kombiniriamo z vsemi pokrivnimi rešetkami iz programa Multiline in pokrovi z rego iz programa Brickslot do obremenitvenega razreda D400 kN.



## Linijski požiralniki ACO Xtradrain



Zbiralnik lahko obračamo okoli svoje osi, za lažje povezovanje s kanalizacijskimi cevmi

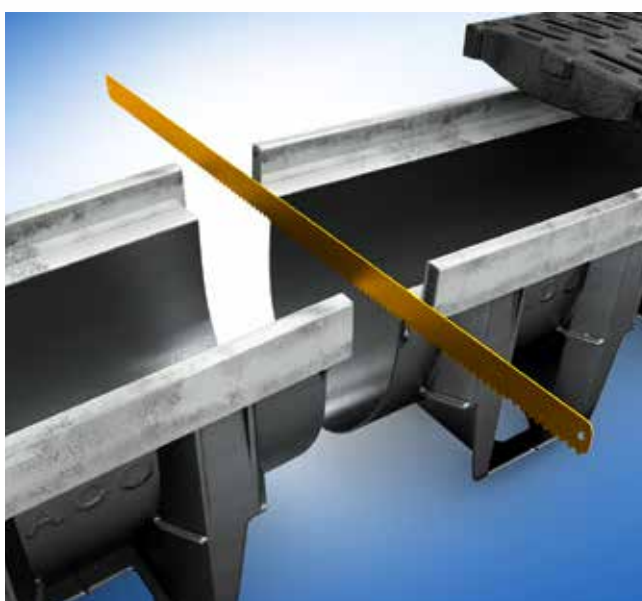

Kanaleta dolžine 50 cm dobimo tako, da z ročno žago na označenem mestu in po vodilu prerežemo kanaleta dolžine 100 cm



## Xtradrain X100 C/X100 S

**Xtradrain X100 kanaleta** iz umetne mase, Drainlock brezvijačno aretiranje pokravnih rešetk, zaščitni rob iz umetne mase ali vročecinkanega jekla, V - presek, varnostni utor (SF) za tesnenje spojev, **svetla širina 10 cm**. Razred obremenitve od A15 do D400 kN po SIST EN 1433.

Gradbena		Gradbena višina		Teža [kg]	Art. št.	EUR brez DDV
dolžina [cm]	širina [cm]	začetek [cm]	konec [cm]			
<b>X100 C rob iz umetne mase</b>						
100	13,8	15,0	15,0	1,9	11000	41,70
<b>X100 S rob iz vročecinkanega jekla</b>						
100	14,2	15,0	15,0	3,5	11100	55,70

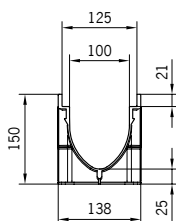
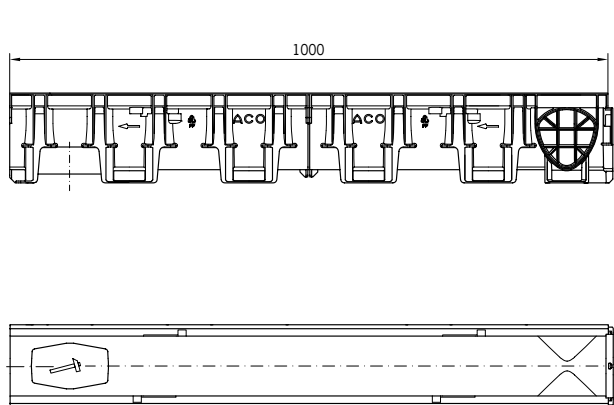

**Xtradrain X100 kanaleta** iz umetne mase, **nizka gradbena višina**.

Gradbena		Gradbena višina		Teža [kg]	Art. št.	EUR brez DDV
dolžina [cm]	širina [cm]	začetek [cm]	konec [cm]			
<b>X100 C rob iz umetne mase</b>						
100	13,8	7,5	7,5	1,0	11004	41,70
100	13,8	10,0	10,0	1,2	11005	41,70
<b>X100 S rob iz vročecinkanega jekla</b>						
100	14,2	7,5	7,5	2,6	11104	55,70
100	14,2	10,0	10,0	2,9	11105	55,70

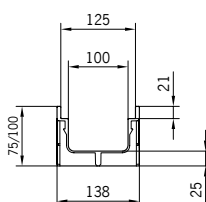
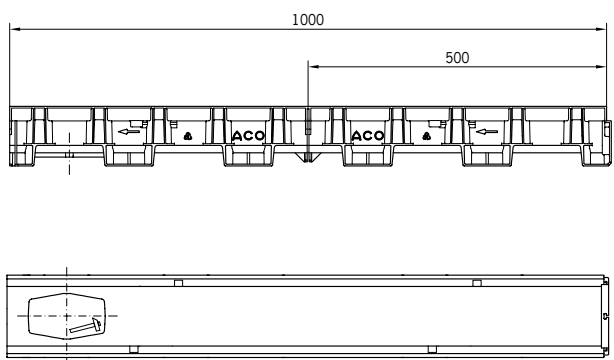

**Xtradrain X100 zbiralnik** iz umetne mase, horizontalni iztok DN100/DN150, tesnilo, vedro za umazanijo. Zbiralnik se montira pod kanaletu.

Tip:	Iztok	Gradbena višina	Teža	Art. št.	EUR brez DDV
		[cm]	[kg]		
Zbiralnik	Horizontalni iztok DN100/DN150	51,2	2,0	11385	89,50

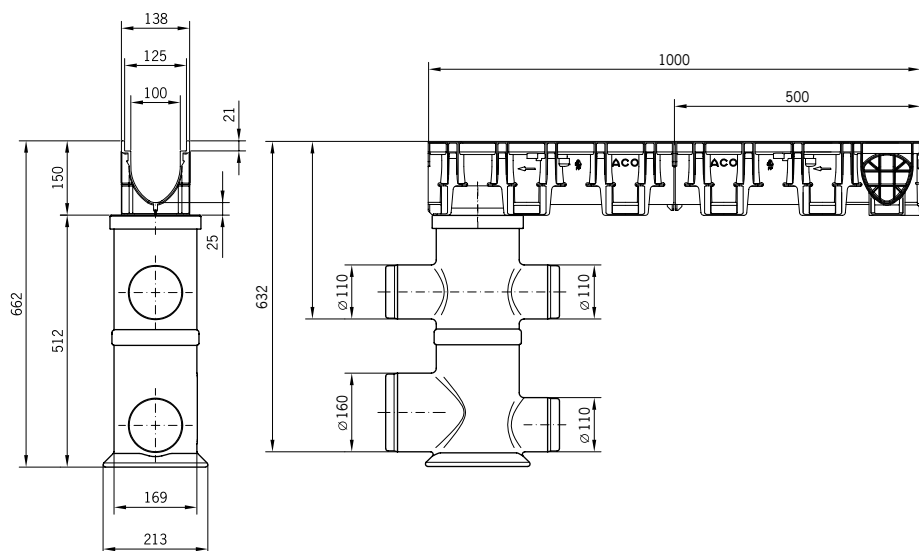





**Xtradrain X100 pribor**

Opis:	Uporabno za:	Teža	Art. št.	EUR brez DDV
		[kg]		
	<ul style="list-style-type: none"> <li>Xtradrain X100 C/X100 S</li> </ul>	0,1	11086	4,40
	<ul style="list-style-type: none"> <li>Xtradrain X100 C/X100 S nizka gradbena višina</li> </ul>	0,1	11085	4,40
	<ul style="list-style-type: none"> <li>Xtradrain X100 C/X100 S</li> </ul>	0,1	11087	5,70
	<ul style="list-style-type: none"> <li>Xtradrain X100 C/X100 S</li> <li>Xtradrain X100 C/X100 S</li> </ul>	0,1 0,1	11285 11286	14,80 14,80
	<ul style="list-style-type: none"> <li>Xtradrain X100 C/X100 S</li> <li>Xtradrain X150 C/X150 S</li> </ul>	1,2 1,4	11191 11192	84,90 84,90

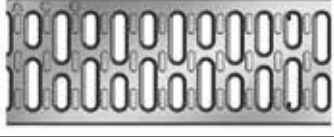

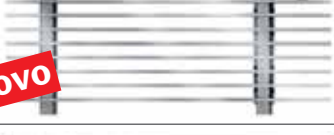







## Xtradrain X100 C/X100 S

**Xtradrain X100** pokrivne rešetke, DrainLock® brezvijačno aretiranje pokravnih rešetk.  
Razred obremenitve od A 15 do E 600 kN po SIST EN 1433.

Opis:	Gradbena		Vtočna površina [cm <sup>2</sup> /m]	Teža [kg]	Art. št.	EUR brez DDV	
	dolžina [cm]	širina [cm]					
<b>Razred obremenitve A15</b>							
	rešetka mostna, SK design, SW 10 mm, vročecinkana	100	12,3	312	2,2	12610	15,80
		50	12,3	312	1,0	12611	11,80
	rešetka mostna, SK design, SW 10 mm, nerjaveča	100	12,3	312	2,2	12640	60,00
		50	12,3	312	1,0	12641	35,30
	rešetka vzdolžna palična, SW 11 mm, vročecinkana	100	12,3	920	3,2	12602	103,80
		50	12,3	920	1,8	12603	68,00
	rešetka vzdolžna palična, SW 11 mm, nerjaveča	100	12,3	920	3,2	12604	178,50
		50	12,3	920	1,8	12605	123,80
	rešetka luknjičasta, 6 mm, vročecinkana	100	12,3	178	2,9	12666	42,20
		50	12,3	178	1,4	12667	25,30
	rešetka luknjičasta, 6 mm, nerjaveča	100	12,3	178	2,9	12664	68,40
		50	12,3	178	1,4	12665	44,10









Xtradrain X100 pokrivne rešetke, DrainLock® brezvijačno aretiranje pokravnih rešetk.  
Razred obremenitve od A 15 do E 600 kN po SIST EN 1433.

	Opis:	Gradbena		Vtočna površina [cm <sup>2</sup> /m]	Teža [kg]	Art. št.	EUR brez DDV
		dolžina [cm]	širina [cm]				
<b>Razred obremenitve B125</b>							
	rešetka, SK design, SW 12 mm, litoželezna	50	12,3	371	2,3	12676	18,30
 <b>NOVO</b>	rešetka mostna, SW 8 mm, kompozitna, Microgrip <sup>2)</sup>	50	12,3	284	0,8	132710	15,30
 <b>NOVO</b>	rešetka mostna, SW 8 mm, kompozitna, srebrnosiva	50	12,3	284	0,8	132267	15,30
 <b>NOVO</b>	rešetka, mrežasta Q+ 30x10 mm, vročecinkana	100	12,3	845	3,2	132560	33,30
		50	12,3	845	1,6	132561	18,70
	rešetka, mrežasta Q+ 30x10 mm, nerjaveča	100	12,3	845	3,2	132559	70,70
		50	12,3	845	1,6	132542	40,60
	rešetka, vzdolžna palična, SW 6 mm, nerjaveča, Heelsafe	100	12,3	465	3,6	132557	94,60
		50	12,3	465	1,8	132552	49,90
	rešetka, vzdolžna profilna <sup>1)</sup> SW 8 mm, vročecinkana	100	12,3	430	3,9	132555	36,40
		50	12,3	430	1,9	132550	19,80
	rešetka, vzdolžna profilna <sup>1)</sup> SW 8 mm, nerjaveča	100	12,3	430	3,9	132556	84,20
		50	12,3	430	1,9	132551	44,70
	rešetka prečna palična, vročecinkana	100	12,3	676	6,5	12606	231,00
		50	12,3	676	3,3	12607	148,00
	rešetka prečna palična, nerjaveča	100	12,3	676	6,5	12608	366,00
		50	12,3	676	3,3	12609	231,00
 <b>NOVO</b>	rešetka SK design, SW 8mm kompozitna, eyeleds bela	50	12,3	280	1	12686	120,30
 <b>NOVO</b>	rešetka SK design, SW 8mm kompozitna, eyeleds modra	50	12,3	280	1	12727	120,30

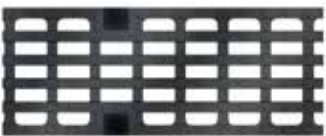
1) Protidrsno R11; ni primerno za področja z bosimi nogami  
2) Protidrsno R13

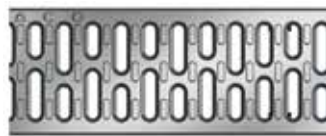
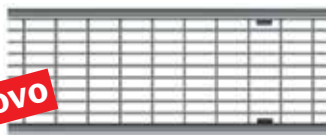



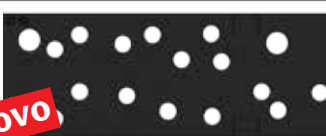

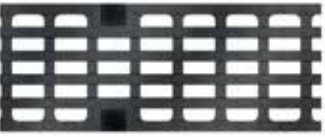

## Xtradrain X100 C/X100 S

Xtradrain X100 pokrivne rešetke, DrainLock® brezvijačno aretiranje pokravnih rešetak.  
Razred obremenitve od A 15 do E 600 kN po SIST EN 1433.

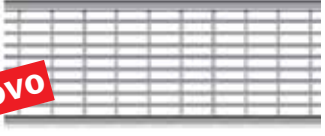

Opis:	Gradbena		Vtočna površina [cm <sup>2</sup> /m]	Teža [kg]	Art. št.	EUR brez DDV	
	dolžina [cm]	širina [cm]					
<b>Razred obremenitve C250</b>							
	rešetka, SK design, SW 12 mm, litoželezna	50	12,3	371	3,2	12670	22,20
	rešetka vzdolžna, MW 31x12 mm, litoželezna	50	12,3	433	3,5	12673	23,60
 <b>NOVO</b>	rešetka mostna SW 8 mm, kompozitna, Microgrip <sup>2)</sup>	50	12,3	284	1,0	132720	21,10
 <b>NOVO</b>	rešetka mostna SW 8 mm, kompozitna, srebrnosiva	50	12,3	284	1,0	132266	21,10
	rešetka ,SK design, SW 10 mm, vročecinkana	100	12,3	312	4,3	12614	46,20
		50	12,3	312	2,2	12615	31,00
	rešetka, SK design, SW 10 mm, nerjaveča	100	12,3	312	4,3	12644	204,00
		50	12,3	312	2,2	12645	95,00
 <b>NOVO</b>	rešetka, mrežasta Q+ 30x10 mm, vročecinkana	100	12,3	880	4,2	132880	63,30
		50	12,3	880	2,1	132881	42,80
	rešetka, mrežasta Q+ 30x10 mm, nerjaveča	100	12,3	880	4,2	132882	povpr.
		50	12,3	880	2,1	132883	povpr.
	rešetka luknjičasta, 6 mm, vročecinkana	100	12,3	178	4,8	12656	70,00
		50	12,3	178	2,3	12657	37,60
	rešetka luknjičasta, 6 mm, nerjaveča	100	12,3	178	4,8	12654	povpr.
		50	12,3	178	2,3	12655	povpr.
 <b>NOVO</b>	design rešetka <b>Home</b> litoželezna EN-GJS, KTL	50	12,3	151	4,9	132103	36,60
 <b>NOVO</b>	design rešetka <b>Leaf</b> litoželezna EN-GJS, KTL	50	12,3	173	4,9	132097	36,60
 <b>NOVO</b>	design rešetka <b>Nature</b> litoželezna EN-GJS, KTL	50	12,3	83	5,0	132096	36,60
 <b>NOVO</b>	design rešetka <b>Dots</b> litoželezna EN-GJS, KTL	50	12,3	52	5,5	132105	36,60

1) Protidrsno R11; ni primerno za področja z bosimi nogami  
2) Protidrsno R13



Xtradrain X100 pokrivne rešetke, DrainLock® brezvijačno aretiranje pokravnih rešetk.  
Razred obremenitve od A 15 do E 600 kN po SIST EN 1433.

	Opis:	Gradbena		Vtočna površina [cm <sup>2</sup> /m]	Teža [kg]	Art. št.	EUR brez DDV
		dolžina [cm]	širina [cm]				
<b>Razred obremenitve D400</b>							
	rešetka, SK design, SW 12 mm, litoželezna	50	12,3	371	3,8	23408	25,60
	rešetka vzdolžna, MW 28x12 mm, litoželezna	50	12,3	433	4,5	12674	26,70
	rešetka, mrežasta Q+ 28x9 mm, vročecinkana	100	12,3	690	5,2	132885	69,60
		50	12,3	690	2,6	132886	45,10
	rešetka, mrežasta Q+ 28x9 mm, nerjaveča	100	12,3	690	5,2	132887	284,50
		50	12,3	690	2,6	132888	148,20
	rešetka za Lightpoint, SW12 mm z luknjo, litoželezna EN-GJS	50	12,3	350	4,1	49505	20,40
	rešetka za Lightpoint, SW12 mm brez luknje, litoželezna EN-GJS	50	12,3	371	4,1	49506	29,10
	design rešetka <b>Home</b> litoželezna EN-GJS, KTL	50	12,3	151	4,9	132102	40,20
	design rešetka <b>Leaf</b> litoželezna EN-GJS, KTL	50	12,3	173	4,9	132063	40,20
	design rešetka <b>Nature</b> litoželezna EN-GJS, KTL	50	12,3	83	5,0	132095	40,20
	design rešetka <b>Dots</b> litoželezna EN-GJS, KTL	50	12,3	52	5,5	132104	40,20

**Nastavki z rego**, za kanalete X100, asimetrična rega, svetla širina rege 10 mm, višina rege 105 mm, razred obremenitve C250 kN po SIST EN 1433.

Opis:		Dolžina [cm]	Širina rege [mm]	Višina rege [mm]	Teža [kg]	Art. št.	EUR brez DDV
<b>Razred obremenitve C250</b>							
	nastavek z rego, vročecinkano jeklo	100,0	10,0	105	5,2	445598	80,00
		50,0	10,0	105	2,7	445599	50,00
	nastavek z rego, nerjaveče jeklo	100,0	10,0	105	5,2	445600	155,00
		50,0	10,0	105	2,7	445601	101,20
	nastavek z rego revizijski, vročecinkano jeklo	50,0	10,0	105	6,0	445603	145,00
	nastavek z rego revizijski, nerjaveče jeklo	50,0	10,0	105	6,0	445602	196,50

**Nastavki z rego**, za kanalete X100, simetrična rega, svetla širina rege 12,5 mm, višina rege 105/150 mm, razred obremenitve D400 kN po SIST EN 1433

Opis:		Dolžina [cm]	Širina rege [mm]	Višina rege [mm]	Teža [kg]	Art. št.	EUR brez DDV
<b>Razred obremenitve D400</b>							
	nastavek rego vročecinkano jeklo	100,0	12,5	105	8,0	49972	88,90
		100,0	12,5	150	8,7	49765	124,00
		50,0	12,5	105	4,0	49973	61,30
		50,0	12,5	150	4,5	49766	84,80
	nastavek rego nerjaveče jeklo	100,0	12,5	105	8,0	49978	172,50
		100,0	12,5	150	8,7	49742	183,10
		50,0	12,5	105	4,0	49979	112,40
		50,0	12,5	150	4,5	49743	128,50
	nastavek z rego revizijski, vročecinkano jeklo	50,0	12,5	105	5,2	49974	194,00
		50,0	12,5	150	13,0	49767	215,00
	nastavek z rego revizijski, nerjaveče jeklo	50,0	12,5	105	5,2	49980	218,40
		50,0	12,5	150	13,0	49744	250,60

**Xtradrain X150 kanaleta** iz umetne mase, Drainlock brezvijačno aretiranje pokravnih rešetk, zaščitni rob iz umetne mase ali vročecinkanega jekla, V - presek, varnostni utor (SF) za tesnenje spojev, **svetla širina 15 cm**. Razred obremenitve od A15 do D400 kN po SIST EN 1433.

Gradbena		Gradbena višina		Teža	Art. št.	EUR brez DDV
dolžina [cm]	širina [cm]	začetek [cm]	konec [cm]	[kg]		
<b>X150 C rob iz umetne mase</b>						
100	18,8	21,0	21,0	2,5	11011	66,80
<b>X150 S rob iz vročecinkanega jekla</b>						
100	19,2	21,0	21,0	4,0	11111	88,80

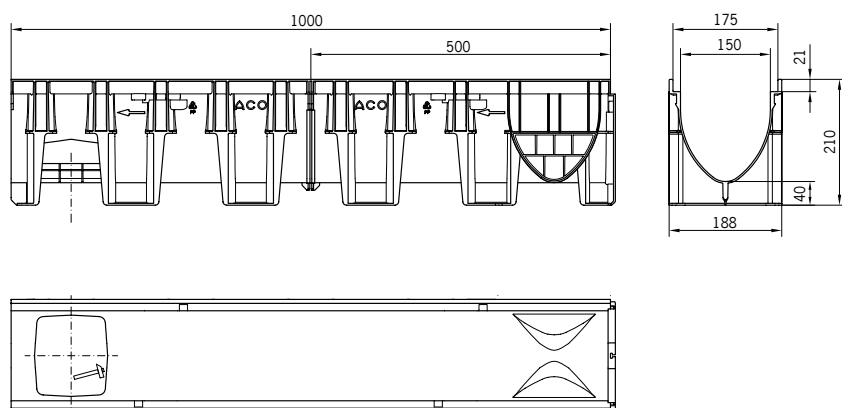



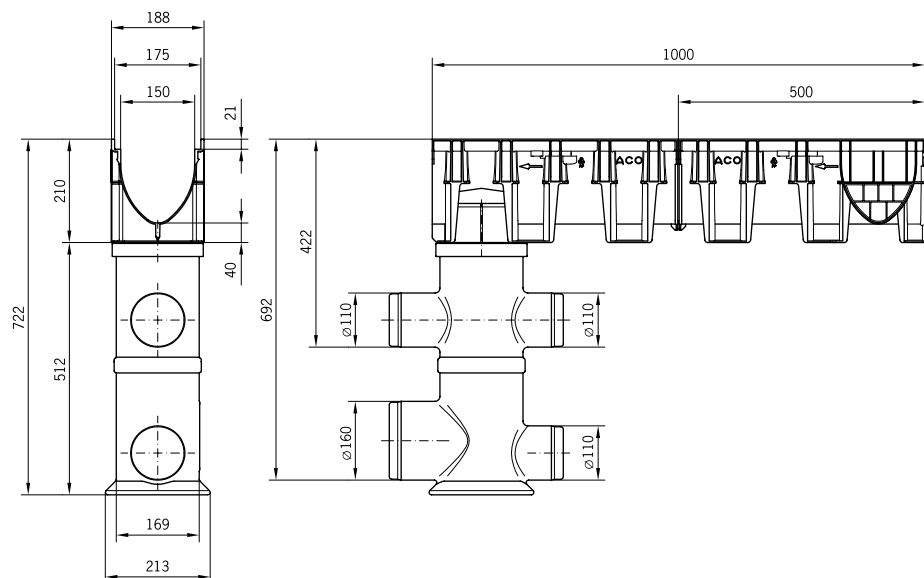

**Xtradrain X150 zbiralnik** iz umetne mase, horizontalni iztok DN100/DN150, tesnilo, vedro za umazanijo. Zbiralnik se montira pod kanaletu.









Tip:	Iztok	Gradbena višina	Teža	Art. št.	EUR brez DDV
		[cm]	[kg]		
Zbiralnik	Horizontalni iztok DN100/DN150	51,2	3,7	11386	147,20



## Xtradrain X150 pribor

	Opis:	Uporabno za:	Teža [kg]	Art. št.	EUR brez DDV
	Čelna stena za začetek in konec kanala iz PP	<ul style="list-style-type: none"> <li>■ Xtradrain X150 C/X150 S</li> </ul>	0,1	11093	9,80
	Čelna stena z iztokom DN150, PP	<ul style="list-style-type: none"> <li>■ Xtradrain X150 C/X150 S</li> </ul>	0,2	11094	11,80
	Iztočni adapter ■ DN150	<ul style="list-style-type: none"> <li>■ Xtradrain X150 C/X150 S</li> </ul>	0,3	11288	20,90
	Sifon s tesnili ■ DN100 ■ DN150	<ul style="list-style-type: none"> <li>■ Xtradrain X100 C/X100 S</li> <li>■ Xtradrain X150 C/X150 S</li> </ul>	1,2 1,4	11191 11192	84,90 84,90







Xtradrain X150 pokrivne rešetke, DrainLock® brezvijačno aretiranje pokravnih rešetk.  
Razred obremenitve od A 15 do E 600 kN po SIST EN 1433.

	Opis:	Gradbena		Vtočna površina [cm <sup>2</sup> /m]	Teža [kg]	Art. št.	EUR brez DDV
		dolžina [cm]	širina [cm]				
<b>Razred obremenitve B125</b>							
	rešetka, mrežasta Q+ 30x10 mm, vročecinkana	100	17,3	1182	5,4	133601	78,40
		50	17,3	1182	2,7	133602	46,40
	rešetka, mrežasta Q+ 30x10 mm, nerjaveča	100	17,3	1182	5,4	133603	244,40
		50	17,3	1182	2,7	133604	130,00
	rešetka, vzdolžna palična, SW 6 mm, nerjaveča, Heelsafe	100	17,3	687	5,1	133633	278,00
		50	17,3	687	2,5	133634	155,60
	rešetka, vzdolžna profilna <sup>1)</sup> , SW 8 mm, vročecinkana	100	17,3	687	5,1	133625	102,40
		50	17,3	687	2,5	133626	64,80
	rešetka, vzdolžna profilna <sup>1)</sup> , SW 8 mm, nerjaveča	100	17,3	687	5,1	133627	234,40
		50	17,3	687	2,5	133628	126,40
<b>Razred obremenitve C250</b>							
	rešetka, SK design, SW 12 mm, litoželezna	50	17,3	578	6,0	13070	36,40
	rešetka vzdolžna, MW 29x12 mm, litoželezna	50	17,3	595	5,3	13073	38,80
	rešetka mrežasta, MW 17x23 mm, vročecinkana	100	17,3	1151	7,4	13018	15230
		50	17,3	1151	3,7	13019	95,70
	rešetka mrežasta, MW 17x23 mm, nerjaveča	100	17,3	1151	7,4	13048	povpr.
		50	17,3	1151	3,7	13049	povpr.
	design rešetka <b>Home</b> litoželezna EN-GJS, KTL	50	17,3	211	8,7	132101	57,60
	design rešetka <b>Leaf</b> litoželezna EN-GJS, KTL	50	17,3	243	8,9	132099	57,60
	design rešetka <b>Nature</b> litoželezna EN-GJS, KTL	50	17,3	133	8,9	132094	57,60

1) Protidrsno R11; ni primerno za področja z bosimi nogami  
2) Protidrsno R13

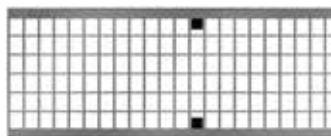
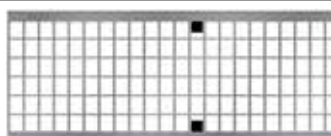

## Xtradrain X150 C/X150 S

Xtradrain X150 pokrivne rešetke, DrainLock® brezvijačno aretiranje pokravnih rešetk.  
Razred obremenitve od A 15 do E 600 kN po SIST EN 1433.



Opis:	Gradbena		Vtočna površina [cm <sup>2</sup> /m]	Teža [kg]	Art. št.	EUR brez DDV	
	dolžina [cm]	širina [cm]					
<b>Razred obremenitve D400</b>							
	rešetka, SK design, SW 12 mm, litoželezna EN-GJS	50	17,3	578	6,4	23164	45,90
	rešetka, vzdolžna MW 25 x 12, litoželezna EN-GJS	50	17,3	578	7,8	13071	49,00
	rešetka mrežasta, MW 17 x 23, vročecinkana	100	17,3	1151	9,2	13020	168,40
		50	17,3	1151	4,6	13021	118,10
	rešetka mrežasta, MW 17 x 23, nerjaveča	100	17,3	1151	9,2	13050	povpr.
		50	17,3	1151	4,6	13051	povpr.
 <b>NOVO</b>	design rešetka <b>Home</b> litoželezna EN-GJS, KTL	50	17,3	211	8,7	132100	65,20
 <b>NOVO</b>	design rešetka <b>Leaf</b> litoželezna EN-GJS, KTL	50	17,3	243	8,9	132098	65,20
 <b>NOVO</b>	design rešetka <b>Nature</b> litoželezna EN-GJS, KTL	50	17,3	133	8,9	132093	65,20



**Nastavki z rego**, za kanalete X150, simetrična rega, svetla širina rege 12,5 mm, višina rege 105 mm, razred obremenitve C250 kN po SIST EN 1433

Opis:		Dolžina [cm]	Širina rege [mm]	Višina rege [mm]	Teža [kg]	Art. št.	EUR brez DDV
<b>Razred obremenitve C250</b>							
	nastavek z rego, vročecinkano jeklo	100,0	12,5	105	7,8	49955	141,60
		50,0	12,5	105	4,0	49956	85,40
	nastavek z rego, nerjaveče jeklo	100,0	12,5	105	7,8	49961	205,90
		50,0	12,5	105	4,0	49962	119,30
	nastavek z rego revizijski, vročecinkano jeklo	50,0	12,5	105	6,8	49957	184,70
	nastavek z rego revizijski, nerjaveče jeklo	50,0	12,5	105	6,8	49963	243,80

**Nastavki z rego**, za kanalete X150, simetrična rega, svetla širina rege 12,5 mm, višina rege 105/150 mm, razred obremenitve D400 kN po SIST EN 1433

Opis:		Dolžina [cm]	Širina rege [mm]	Višina rege [mm]	Teža [kg]	Art. št.	EUR brez DDV
<b>Razred obremenitve D400</b>							
	nastavek rego vročecinkano jeklo	100,0	12,5	105	10,5	49975	135,20
		100,0	12,5	150	13,0	49021	175,00
		50,0	12,5	105	7,0	49976	96,30
		50,0	12,5	150	5,3	49022	122,00
	nastavek rego nerjaveče jeklo	100,0	12,5	105	10,5	49981	229,00
		100,0	12,5	150	13,0	49783	245,00
		50,0	12,5	105	7,0	49982	148,00
		50,0	12,5	150	5,3	49784	172,00
	nastavek z rego revizijski, vročecinkano jeklo	50,0	12,5	105	8,0	49977	243,30
		50,0	12,5	150	14,5	49023	275,80
	nastavek z rego revizijski, nerjaveče jeklo	50,0	12,5	105	8,0	49983	292,90
		50,0	12,5	150	14,5	49785	335,20

## Xtradrain X200 C/X200 S

**Xtradrain X200 kanaleta** iz umetne mase, Drainlock brezvijačno aretiranje pokravnih rešetk, zaščitni rob iz umetne mase ali vročecinkanega jekla, V - presek, varnostni utor (SF) za tesnenje spojev, **svetla širina 20 cm**. Razred obremenitve od A15 do D400 kN po SIST EN 1433.

Gradbena		Gradbena višina		Teža [kg]	Art. št.	EUR brez DDV
dolžina [cm]	širina [cm]	začetek [cm]	konec [cm]			
<b>X200 C rob iz umetne mase</b>						
100	23,8	26,5	26,5	3,4	11018	81,90
<b>X200 S rob iz vročecinkanega jekla</b>						
100	24,2	26,5	26,5	4,9	11118	109,20

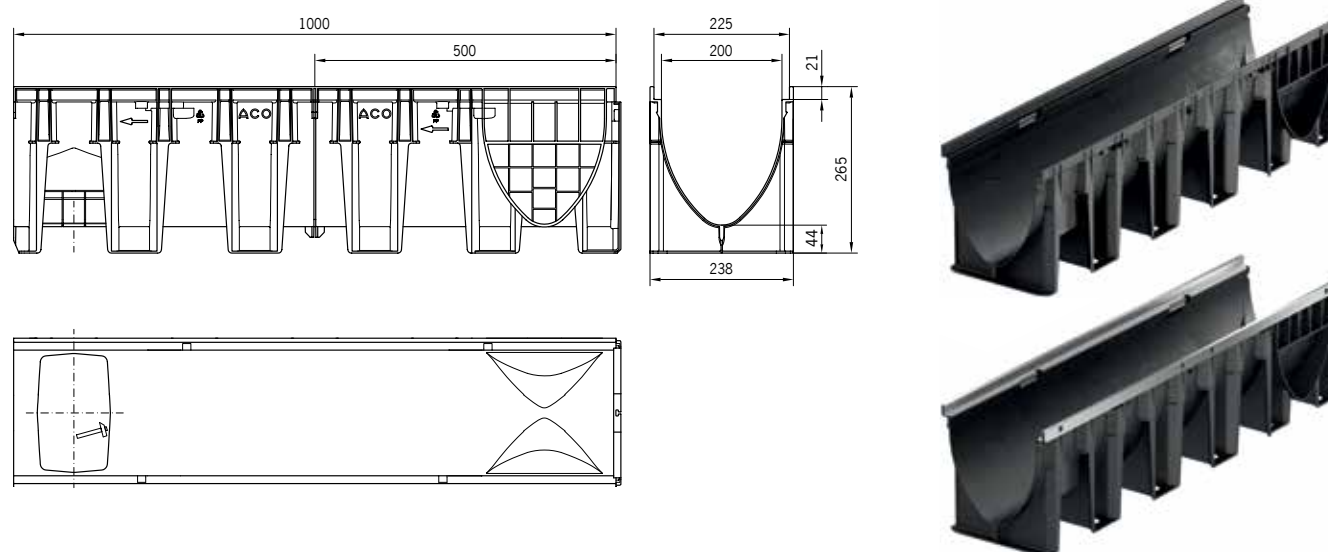

**Xtradrain X200 zbiralnik** iz umetne mase, horizontalni iztok DN100/DN150/DN200, tesnilo, vedro za umazanijo. Zbiralnik se montira pod kanaletu.

Tip:	Iztok	Gradbena višina [cm]	Teža [kg]	Art. št.	EUR brez DDV
Zbiralnik	Horizontalni iztok DN100/DN150/DN200	51,2	4,9	11387	191,20

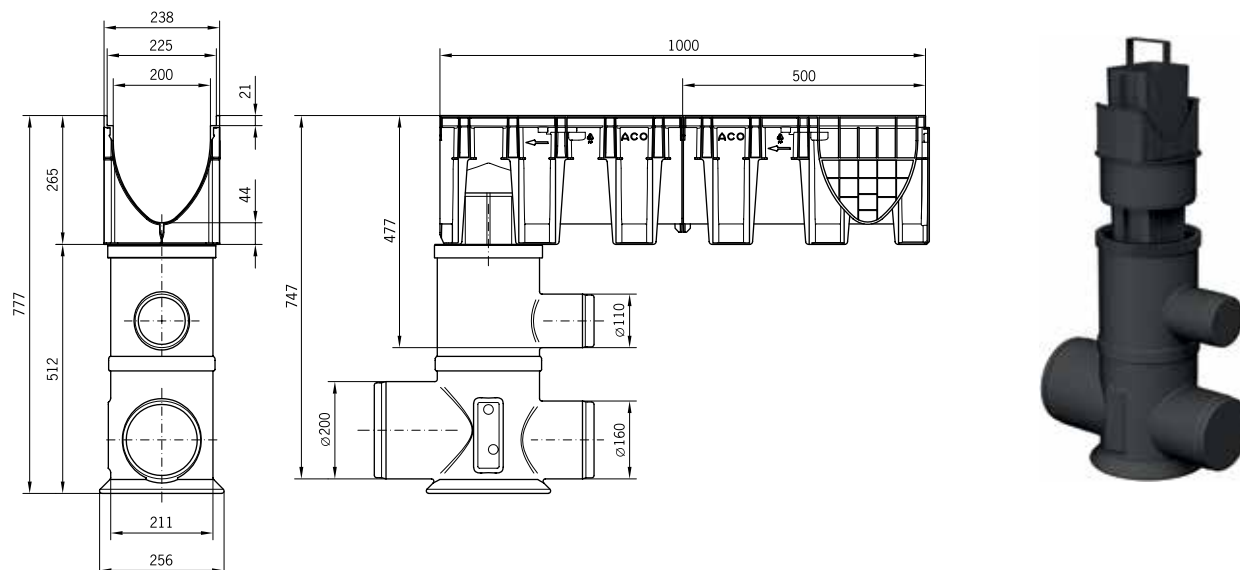









Xtradrain X200 pribor



	Opis:	Uporabno za:	Teža [kg]	Art. št.	EUR brez DDV
	<p>Čelna stena za začetek in konec kanala iz PP</p>	<ul style="list-style-type: none"> <li>■ Xtradrain X200 C/X200 S</li> </ul>	0,1	11098	13,70
	<p>Čelna stena z iztokom DN200, PP</p>	<ul style="list-style-type: none"> <li>■ Xtradrain X200 C/X200 S</li> </ul>	0,2	11098	16,50
	<p>Iztočni adapter ■ DN200</p>	<ul style="list-style-type: none"> <li>■ Xtradrain X200 C/X200 S</li> </ul>	0,4	11289	27,40
	<p>Sifon s tesnili ■ DN150</p>	<ul style="list-style-type: none"> <li>■ Xtradrain X200 C/X200 S</li> </ul>	1,4	11192	84,90

## Xtradrain X200 C/X200 S



Xtradrain X200 pokrivne rešetke, DrainLock® brezvijačno aretiranje pokravnih rešetk.  
Razred obremenitve od A 15 do E 600 kN po SIST EN 1433.

	Opis:	Gradbena		Vtočna površina [cm <sup>2</sup> /m]	Teža [kg]	Art. št.	EUR brez DDV
		dolžina [cm]	širina [cm]				
<b>Razred obremenitve B125</b>							
	rešetka, mrežasta Q+ 30x10 mm, vročecinkana	100	22,3	1575	7,4	133613	97,60
		50	22,3	1575	3,6	133614	58,00
	rešetka, mrežasta Q+ 30x10 mm, nerjaveča	100	22,3	1575	7,4	133615	274,40
		50	22,3	1575	3,6	133616	144,40
	rešetka, vzdolžna palična, SW 6 mm, nerjaveča, Heelsafe	100	22,3	867	7,4	133635	354,00
		50	22,3	867	3,6	133636	199,20
	rešetka, vzdolžna profilna <sup>1)</sup> , SW 8 mm, vročecinkana	100	22,3	846	7,4	133629	132,80
		50	22,3	846	3,6	133630	71,60
	rešetka, vzdolžna profilna <sup>1)</sup> , SW 8 mm, nerjaveča	100	22,3	846	7,4	133631	32,60
		50	22,3	846	3,6	133632	171,20
<b>Razred obremenitve C250</b>							
	rešetka, SK design, SW 12 mm, litoželezna	50	22,3	740	8,6	13470	50,50
	rešetka vzdolžna, MW 31x14 mm, litoželezna	50	22,3	905	7,5	13473	52,50
	rešetka mrežasta, MW 17x23 mm, vročecinkana	100	22,3	1541	12,0	13418	172,10
		50	22,3	1541	6,0	13419	121,70
	rešetka mrežasta, MW 17x23 mm, nerjaveča	100	22,3	1541	12,0	13448	povpr.
		50	22,3	1541	6,0	13449	povpr.

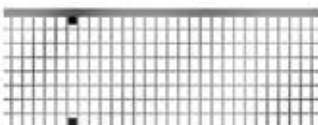
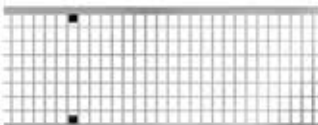
**Xtradrain X200** pokrivne rešetke, DrainLock® brezvijačno aretiranje pokravnih rešetk.  
Razred obremenitve od A 15 do E 600 kN po SIST EN 1433.

Opis:	Gradbena		Vtočna površina [cm <sup>2</sup> /m]	Teža [kg]	Art. št.	EUR brez DDV	
	dolžina [cm]	širina [cm]					
<b>Razred obremenitve D400</b>							
	rešetka, SK design, SW 12 mm, litoželezna	50	22,3	740	9,60	13471	60,90
	rešetka vzdolžna, MW 25x12 mm, litoželezna	50	22,3	756	11,6	13474	65,00
	rešetka mrežasta, MW 16x22 mm, vročecinkana	100	22,3	1391	16,00	13420	255,00
		50	22,3	1391	7,90	13421	161,00
	rešetka mrežasta, MW 16x22 mm, nerjaveča	100	22,3	1391	16,00	13450	povpr.
		50	22,3	1391	7,90	13451	povpr.

**Nastavki z rego**, za kanalete X200, asimetrična rega, svetla širina rege 12,5 mm, višina rege 105 mm, razred obremenitve C250 kN po SIST EN 1433

Opis:	Dolžina [cm]	Širina rege [mm]	Višina rege [mm]	Teža [kg]	Art. št.	EUR brez DDV	
							<b>Razred obremenitve C250</b>
	nastavek z rego, vročecinkano jeklo	100,0	12,5	105	8,9	407063	151,00
		50,0	12,5	105	4,5	407037	92,00
	nastavek z rego, nerjaveče jeklo	100,0	12,5	105	8,9	407039	215,00
		50,0	12,5	105	4,5	407040	124,00
	nastavek z rego revizijski, vročecinkano jeklo	50,0	12,5	105	8,0	407038	195,00
	nastavek z rego revizijski, nerjaveče jeklo	50,0	12,5	105	8,0	407041	256,00

Nastavki z rego D400 kN po naročilu.