

ACO Deckline P 100

Prednosti:

- Lahek polimerni beton z gladko površino
 - Vodotesen, odporen na kemikalije, zmrzal in tališno sol
 - ACO Drain varnostni utor
 - Drainlock brezvijačno aretiranje pokravnih rešetk
 - Zaščitni rob iz polimernega betona
- Skladno s SIST EN 1433
 - Svetla širina 100 mm
 - Razred obremenitve A 15 do C 250 kN

Kanalete brez vgrajenega padca, dolžina 100 cm

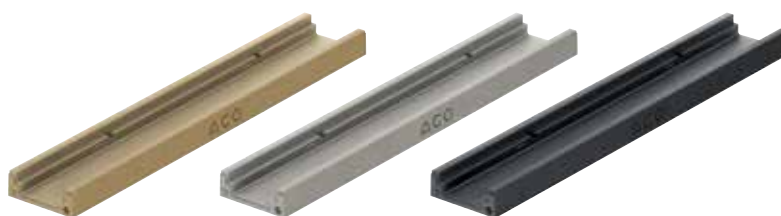

Dimenzije					Natur		Siva		Antracit	
Dolžina [mm]	Širina [mm]	Višina [mm]	Tip	Teža [mm]	Art. št.	EUR brez DDV	Art. št.	EUR brez DDV	Art. št.	EUR brez DDV
1000	172	60	0.0	12,1	135070	44,00	135072	46,00	135074	49,00

Kanalete brez vgrajenega padca, dolžina 100 cm

Z vgrajenim iztokom v dno DN 100







Dimenzije					Natur		Siva		Antracit	
Dolžina [mm]	Širina [mm]	Višina [mm]	Tip	Teža [mm]	Art. št.	EUR brez DDV	Art. št.	EUR brez DDV	Art. št.	EUR brez DDV
1000	172	60	0.0.3	11,7	135071	46,00	135072	49,00	135075	52,00



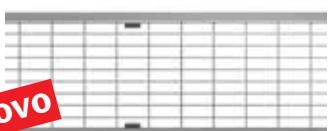

Pribor

	Opis:	Primerno za:	Teža [kg]	Art. št.	EUR brez DDV
	<p>Čelna stena</p> <ul style="list-style-type: none"> ■ Za začetek in konec kanala ■ Polimerni beton ■ Barva: natur 	Deckline P 100	0,4	135076	6,00
	<p>Čelna stena</p> <ul style="list-style-type: none"> ■ Za začetek in konec kanala ■ Polimerni beton ■ Barva: siva 	Deckline P 100	0,4	135077	6,60
	<p>Čelna stena</p> <ul style="list-style-type: none"> ■ Za začetek in konec kanala ■ Polimerni beton ■ Barva: antracit 	Deckline P 100	0,4	135078	7,00
	<p>Požiralnik vmesni element</p> <ul style="list-style-type: none"> ■ Nerjaveče jeklo ■ Tlačna prirobnica za priključitev folije ■ Drenažne odprtine ■ DN 100 	Iztok DN 100	5,0	01043	190,00
	<p>Kljuka majhna</p> <ul style="list-style-type: none"> ■ Za dvig pokravnih rešetk ■ Vročecinkano jeklo 	Mrežasta Q+ Kompozitna Profilna Palična Heelsafe	0,3	01367	15,00

Pokrivne rešetke za Deckline P 100

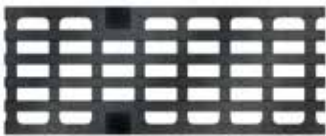
	Opis:	Gradbena		Vtočna površina [cm ² /m]	Teža [kg]	Art. št.	EUR brez DDV
		dolžina [cm]	širina [cm]				
Razred obremenitve B125							
	rešetka, SK design, SW 12 mm, litoželezna	50	12,3	371	2,3	12676	18,30
NOVO 	rešetka mostna, SW 8 mm, kompozitna, Microgrip ²⁾	50	12,3	284	0,8	132710	15,30
NOVO 	rešetka mostna, SW 8 mm, kompozitna, srebrnosiva	50	12,3	284	0,8	132267	15,30
NOVO 	rešetka, mrežasta Q+ 30x10 mm, vročecinkana	100	12,3	845	3,2	132560	33,30
		50	12,3	845	1,6	132561	18,70
	rešetka, mrežasta Q+ 30x10 mm, nerjaveča	100	12,3	845	3,2	132559	70,70
		50	12,3	845	1,6	132542	40,60
	rešetka, vzdolžna palična, SW 6 mm, nerjaveča, Heelsafe	100	12,3	465	3,6	132557	94,60
		50	12,3	465	1,8	132552	49,90
	rešetka, vzdolžna profilna ¹⁾ SW 8 mm, vročecinkana	100	12,3	430	3,9	132555	36,40
		50	12,3	430	1,9	132550	19,80
	rešetka, vzdolžna profilna ¹⁾ SW 8 mm, nerjaveča	100	12,3	430	3,9	132556	84,20
		50	12,3	430	1,9	132551	44,70

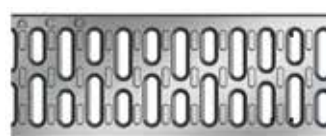
Pokrivne rešetke za Deckline P 100

	Opis:	Gradbena		Vtočna površina [cm ² /m]	Teža [kg]	Art. št.	EUR brez DDV
		dolžina [cm]	širina [cm]				
Razred obremenitve C250							
	rešetka, SK design, SW 12 mm, litoželezna	50	12,3	371	3,2	12670	22,20
	rešetka vzdolžna, MW 31x12 mm, litoželezna	50	12,3	433	3,5	12673	23,60
 NOVO	rešetka mostna SW 8 mm, kompozitna, Microgrip ²⁾	50	12,3	284	1,0	132720	21,10
 NOVO	rešetka mostna SW 8 mm, kompozitna, srebr- nosiva	50	12,3	284	1,0	132266	21,10
	rešetka ,SK design, SW 10 mm, vročecinkana	100	12,3	312	4,3	12614	46,20
		50	12,3	312	2,2	12615	31,00
	rešetka, SK design, SW 10 mm, nerjaveča	100	12,3	312	4,3	12644	204,00
		50	12,3	312	2,2	12645	95,00
 NOVO	rešetka, mrežasta Q+ 30x10 mm, vročecinkana	100	12,3	880	4,2	132880	63,30
		50	12,3	880	2,1	132881	42,80
	rešetka, mrežasta Q+ 30x10 mm, nerjaveča	100	12,3	880	4,2	132882	povpr.
		50	12,3	880	2,1	132883	povpr.

ACO Deckline S 100

Prednosti:

- Material nerjaveče jeklo 1.4301 (po naročilu 1.4404)
 - Vodotesna vgradnja
 - Integriran tesnilni trak
 - Drainlock brezvijačno aretiranje pokravnih rešetk
 - Zaščitni rob iz nerjavečega jekla
 - Priporočljivo za betonske površine
- Skladno s SIST EN 1433
 - Svetla širina 100 mm
 - Razred obremenitve A 15 do C 250 kN





Kanalete brez vgrajenega padca, dolžina 100 in 50 cm

- Z ali brez iztoka DN 100
- Z ali brez zaključne stene
- Brez veznega elementa







Dolžina [mm]	Dimenzije		Teža [mm]	Art. št.	EUR brez DDV
	Širina [mm]	Višina [mm]			
Kanaleta 100 cm					
1000	136	54	5,2	445544	78,00
Kanaleta 50 cm					
500	136	54	2,5	445545	55,00
Kanaleta 100 cm z iztokom DN 100 na sredini					
1000	136	54	5,4	445593	138,00
Kanaleta 50 cm z enostransko čelno steno					
500	136	54	2,6	445546	76,00
Kanaleta 50 cm z enostransko čelno steno in iztokom DN 100 na koncu					
500	136	54	3,0	445547	111,00



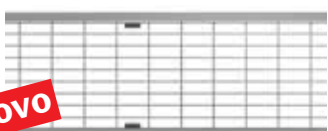

Pribor

	Opis:	Primerno za:	Teža [kg]	Art. št.	EUR brez DDV
	Vezni element vmesni ■ Za spoj dveh kanalet ■ Nerjaveče jeklo ■ S tesnilnim trakom	Deckline S 100	0,5	445552	25,00
	Pritrdilni element ■ Za konec kanalete ■ Nerjaveče jeklo	Deckline S 100	0,2	445553	25,00
	Požiralnik vmesni element ■ Nerjaveče jeklo ■ Tlačna prirobnica za priključitev folije ■ Drenažne odprtine ■ DN 100	Iztok DN 100	5,0	01043	190,00
	Kljuka majhna ■ Za dvig pokravnih rešetk ■ Vročecinkano jeklo	Mrežasta Q+ Kompozitna Profilna Palična Heelsafe	0,3	01367	15,00

Pokrivne rešetke za Deckline S 100

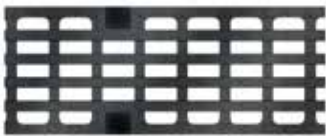
	Opis:	Gradbena		Vtočna površina [cm ² /m]	Teža [kg]	Art. št.	EUR brez DDV
		dolžina [cm]	širina [cm]				
Razred obremenitve B125							
	rešetka, SK design, SW 12 mm, litoželezna	50	12,3	371	2,3	12676	18,30
NOVO 	rešetka mostna, SW 8 mm, kompozitna, Microgrip ²⁾	50	12,3	284	0,8	132710	15,30
NOVO 	rešetka mostna, SW 8 mm, kompozitna, srebrnosiva	50	12,3	284	0,8	132267	15,30
NOVO 	rešetka, mrežasta Q+ 30x10 mm, vročecinkana	100	12,3	845	3,2	132560	33,30
		50	12,3	845	1,6	132561	18,70
	rešetka, mrežasta Q+ 30x10 mm, nerjaveča	100	12,3	845	3,2	132559	70,70
		50	12,3	845	1,6	132542	40,60
	rešetka, vzdolžna palična, SW 6 mm, nerjaveča, Heelsafe	100	12,3	465	3,6	132557	94,60
		50	12,3	465	1,8	132552	49,90
	rešetka, vzdolžna profilna ¹⁾ SW 8 mm, vročecinkana	100	12,3	430	3,9	132555	36,40
		50	12,3	430	1,9	132550	19,80
	rešetka, vzdolžna profilna ¹⁾ SW 8 mm, nerjaveča	100	12,3	430	3,9	132556	84,20
		50	12,3	430	1,9	132551	44,70

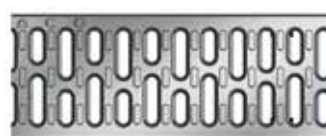
Pokrivne rešetke za Deckline S 100

	Opis:	Gradbena		Vtočna površina [cm ² /m]	Teža [kg]	Art. št.	EUR brez DDV
		dolžina [cm]	širina [cm]				
Razred obremenitve C250							
	rešetka, SK design, SW 12 mm, litoželezna	50	12,3	371	3,2	12670	22,20
	rešetka vzdolžna, MW 31x12 mm, litoželezna	50	12,3	433	3,5	12673	23,60
NOVO 	rešetka mostna SW 8 mm, kompozitna, Microgrip ²⁾	50	12,3	284	1,0	132720	21,10
NOVO 	rešetka mostna SW 8 mm, kompozitna, srebr- nosiva	50	12,3	284	1,0	132266	21,10
	rešetka ,SK design, SW 10 mm, vročecinkana	100	12,3	312	4,3	12614	46,20
		50	12,3	312	2,2	12615	31,00
	rešetka, SK design, SW 10 mm, nerjaveča	100	12,3	312	4,3	12644	204,00
		50	12,3	312	2,2	12645	95,00
NOVO 	rešetka, mrežasta Q+ 30x10 mm, vročecinkana	100	12,3	880	4,2	132880	63,30
		50	12,3	880	2,1	132881	42,80
	rešetka, mrežasta Q+ 30x10 mm, nerjaveča	100	12,3	880	4,2	132882	povpr.
		50	12,3	880	2,1	132883	povpr.

ACO Deckline S 100

Prednosti:

- Material nerjaveče jeklo 1.4301 (po naročilu 1.4404)
 - Vodotesna vgradnja
 - Integriran tesnilni trak
 - Drainlock brezvijačno aretiranje pokravnih rešetk
 - Zaščitni rob iz nerjavečega jekla
 - Priporočljivo za površine s premazom
- Skladno s SIST EN 1433
 - Svetla širina 100 mm
 - Razred obremenitve A 15 do C 250 kN





Kanalete brez vgrajenega padca, dolžina 100 in 50 cm

- Z ali brez iztoka DN 100
- Z ali brez zaključne stene
- Brez veznega elementa







Dolžina [mm]	Dimenzije		Teža [mm]	Art. št.	EUR brez DDV
	Širina [mm]	Višina [mm]			
Kanaleta 100 cm					
1000	230	54	7,8	445548	115,00
Kanaleta 50 cm					
500	230	54	3,9	445549	75,00
Kanaleta 100 cm z iztokom DN 100 na sredini					
1000	230	54	8,1	445595	160,00
Kanaleta 50 cm z enostransko čelno steno					
500	230	54	4,1	445550	112,00
Kanaleta 50 cm z enostransko čelno steno in iztokom DN 100 na koncu					
500	230	54	4,5	445551	147,00



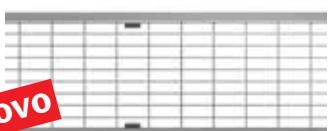

Pribor

	Opis:	Primerno za:	Teža [kg]	Art. št.	EUR brez DDV
	<p>Vezni element vmesni</p> <ul style="list-style-type: none"> ■ Za spoj dveh kanalet ■ Nerjaveče jeklo ■ S tesnilnim trakom 	Deckline S 100	0,5	445552	25,00
	<p>Pritrdilni element</p> <ul style="list-style-type: none"> ■ Za konec kanalete ■ Nerjaveče jeklo 	Deckline S 100	0,2	445553	25,00
	<p>Požiralnik vmesni element</p> <ul style="list-style-type: none"> ■ Nerjaveče jeklo ■ Tlačna prirobnica za priključitev folije ■ Drenažne odprtine ■ DN 100 	Iztok DN 100	5,0	01043	190,00
	<p>Kljuka majhna</p> <ul style="list-style-type: none"> ■ Za dvig pokravnih rešetk ■ Vročecinkano jeklo 	Mrežasta Q+ Kompozitna Profilna Palična Heelsafe	0,3	01367	15,00

Pokrivne rešetke za Deckline S 100

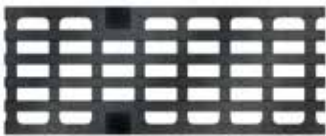
	Opis:	Gradbena		Vtočna površina [cm ² /m]	Teža [kg]	Art. št.	EUR brez DDV
		dolžina [cm]	širina [cm]				
Razred obremenitve B125							
	rešetka, SK design, SW 12 mm, litoželezna	50	12,3	371	2,3	12676	18,30
NOVO 	rešetka mostna, SW 8 mm, kompozitna, Microgrip ²⁾	50	12,3	284	0,8	132710	15,30
NOVO 	rešetka mostna, SW 8 mm, kompozitna, srebrnosiva	50	12,3	284	0,8	132267	15,30
NOVO 	rešetka, mrežasta Q+ 30x10 mm, vročecinkana	100	12,3	845	3,2	132560	33,30
		50	12,3	845	1,6	132561	18,70
	rešetka, mrežasta Q+ 30x10 mm, nerjaveča	100	12,3	845	3,2	132559	70,70
		50	12,3	845	1,6	132542	40,60
	rešetka, vzdolžna palična, SW 6 mm, nerjaveča, Heelsafe	100	12,3	465	3,6	132557	94,60
		50	12,3	465	1,8	132552	49,90
	rešetka, vzdolžna profilna ¹⁾ SW 8 mm, vročecinkana	100	12,3	430	3,9	132555	36,40
		50	12,3	430	1,9	132550	19,80
	rešetka, vzdolžna profilna ¹⁾ SW 8 mm, nerjaveča	100	12,3	430	3,9	132556	84,20
		50	12,3	430	1,9	132551	44,70

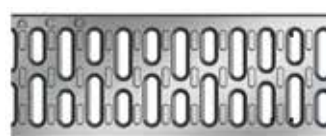
Pokrivne rešetke za Deckline S 100

	Opis:	Gradbena		Vtočna površina [cm ² /m]	Teža [kg]	Art. št.	EUR brez DDV
		dolžina [cm]	širina [cm]				
Razred obremenitve C250							
	rešetka, SK design, SW 12 mm, litoželezna	50	12,3	371	3,2	12670	22,20
	rešetka vzdolžna, MW 31x12 mm, litoželezna	50	12,3	433	3,5	12673	23,60
 NOVO	rešetka mostna SW 8 mm, kompozitna, Microgrip ²⁾	50	12,3	284	1,0	132720	21,10
 NOVO	rešetka mostna SW 8 mm, kompozitna, srebr- nosiva	50	12,3	284	1,0	132266	21,10
	rešetka ,SK design, SW 10 mm, vročecinkana	100	12,3	312	4,3	12614	46,20
		50	12,3	312	2,2	12615	31,00
	rešetka, SK design, SW 10 mm, nerjaveča	100	12,3	312	4,3	12644	204,00
		50	12,3	312	2,2	12645	95,00
 NOVO	rešetka, mrežasta Q+ 30x10 mm, vročecinkana	100	12,3	880	4,2	132880	63,30
		50	12,3	880	2,1	132881	42,80
	rešetka, mrežasta Q+ 30x10 mm, nerjaveča	100	12,3	880	4,2	132882	povpr.
		50	12,3	880	2,1	132883	povpr.

Vgradnja v asfalt, razred A 15 do C 250 kN

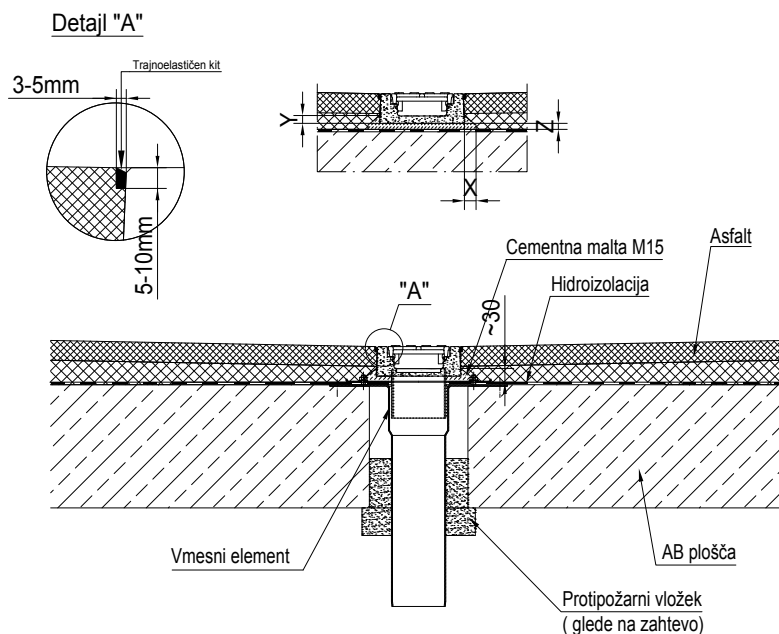

Razred obremenitve	(po SIST EN 1433)	A 15	B 125	C 250
Potrebne dimenzije – kanaleta Tip M (po SIST EN 1433)	X [cm]	≤ 3	≤ 3	≤ 3
	Y [cm]	≤ 1,5	≤ 1,5	≤ 1,5
	Z [cm]	≤ 1,5	≤ 1,5	≤ 1,5

Vgradnja v beton, razred A 15 do C 250 kN

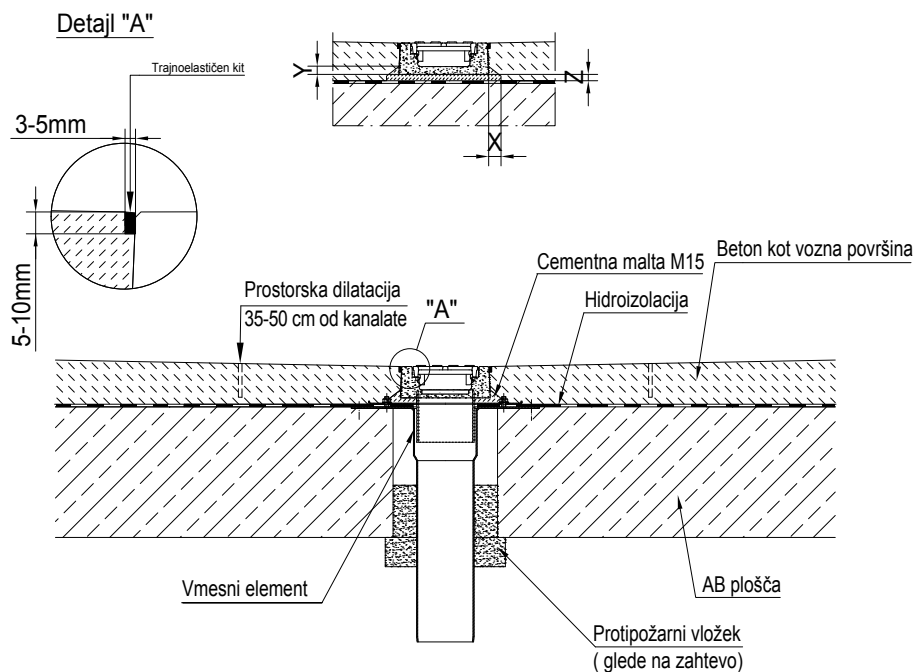

Razred obremenitve	(po SIST EN 1433)	A 15	B 125	C 250
Potrebne dimenzije – kanaleta Tip M (po SIST EN 1433)	X [cm]	≤ 3	≤ 3	≤ 3
	Y [cm]	≤ 1,5	≤ 1,5	≤ 1,5
	Z [cm]	≤ 1,5	≤ 1,5	≤ 1,5

Vgradnja v beton, razred A 15 do C 250 kN

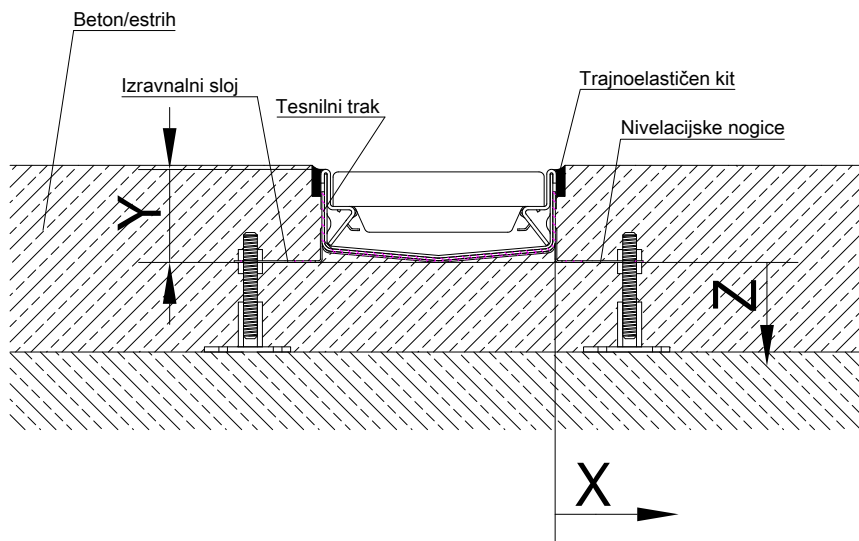

Razred obremenitve	(po SIST EN 1433)	A 15	B 125	C 250
Tlačna trdnost podložnega betona	(po SIST EN 1433)	≤ C 30/37	≤ C 30/37	≤ C 30/37
Potrebne dimenzije – kanaleta Tip M (po SIST EN 1433)	X [cm]	≤ 10	≤ 10	≤ 10
	Y [cm]	Gradbena višina elementa		
	Z [cm]	≤ 3	≤ 3	≤ 3

Vgradnja v površino s premazom, razred A 15 do C 250 kN

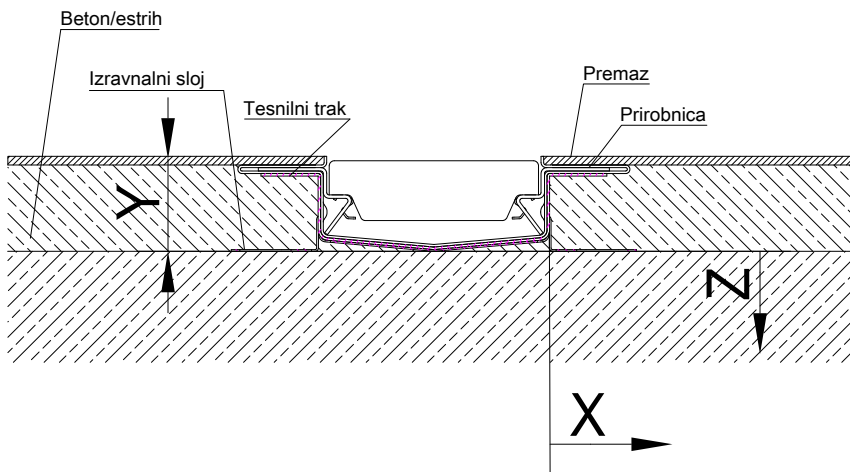

Razred obremenitve	(po SIST EN 1433)	A 15	B 125	C 250
Tlačna trdnost podložnega betona	(po SIST EN 1433)	≤ C 30/37	≤ C 30/37	≤ C 30/37
Potrebne dimenzije – kanaleta Tip M (po SIST EN 1433)	X [cm]	≤ 15	≤ 15	≤ 15
	Y [cm]	Gradbena višina elementa		
	Z [cm]	≤ 3	≤ 3	≤ 3