

Detajl X in Y

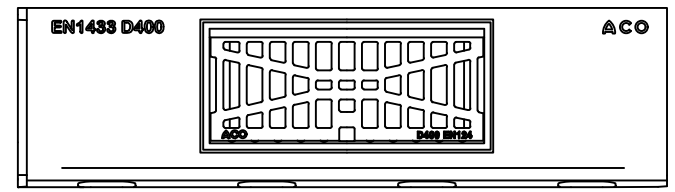

Prerez B-B

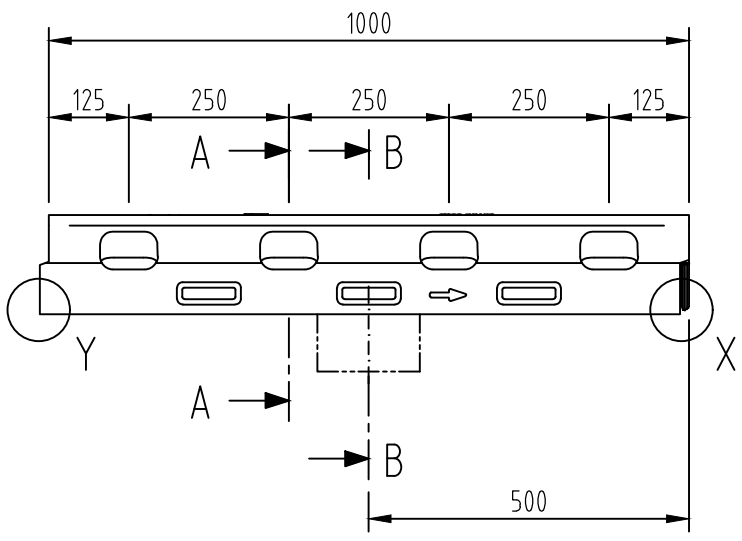
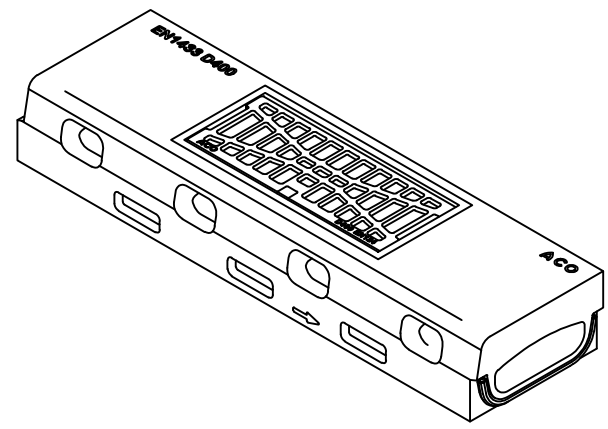
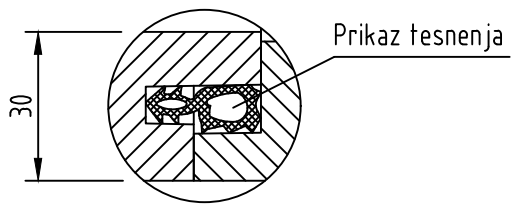
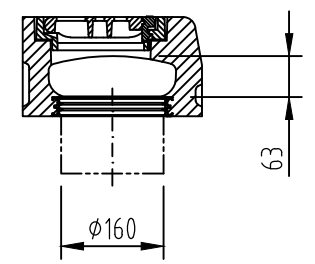

Prerez A-A

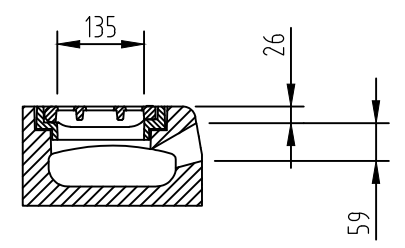

Prikazana je desna izvedba kanalete  
 Material: Polimerni beton  
 Vezni material: Poliesterska smola  
 Material tesnila: EPDM

<b>Benennung:</b> ACO DRAIN Kerbdrain KD 200 -75 Desna revizija s tesnilom, DN/OD 160, L1000 mm, H155 mm, Art.- Št. 133834 ( desni ), 133833 ( levi )	<b>Datum</b> 17.07.2017	<b>Name</b> debeling	 ACO gradbeni elementi, zastopanje, d.o.o. Lenu ulica 6, 3220 Senj pri Tel. 03/877 18 88 www.aco.si	<b>Zeichnung-Nr.</b> G1-M01-1623-3	<b>Index</b> 000			
	<b>Gez.</b>	<b>Upd.</b>				<b>Norm</b>		
	<b>Technische Änderungen vorbehalten</b>					<b>Schutzvermerk gemäß DIN 34</b>	<b>Ers. für:</b>	