

Sistem linijskih požiralnikov

za največje obremenitve od A 15 do F 900 kN

ACO DRAIN® S 100 K do S 300 K z Powerlock®
 prometno varnim brezvijačnim aretiranjem pokravnih rešetk

Inovativnost in varnost –

Litoželezna pokrivna rešetka z brezvijačnim aretiranjem za največje obremenitve

Novo pokrivne rešetke so tako optično, kot funkcionalno dovršene:

- *Konstrukcija pokrivnih rešetak omogoča prenašanje najtežjih obremenitev, vse do F 900 kN*
- *Rešetke imajo velik vtočni presek*
- *Vzdolžne prečke in izbokline na površini rešetke onemogočajo pretok vode čez rešetko*
- *Samo štiri aretiranja rešetke na meter kanalete, poenostavlja montažo in vzdrževanje*
- *V litoželezen okvir na kanaleti vgrajena sidra, onemogočajo vzdolžno premikanje in izpadanje rešetak*
- *Pokrivne rešetke so dodatno zaščitne s premazom*

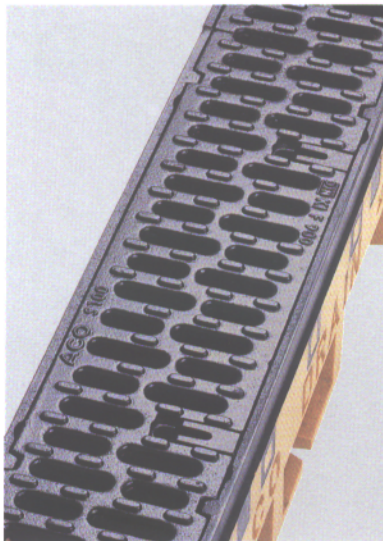

Optično in funkcionalno dovršena pokrivna rešetka

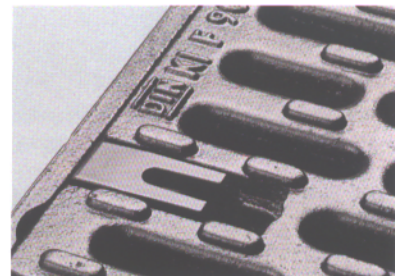

Powerlock® zaklep za brezvijačno aretiranje pokrivne rešetke



...enostavna demontaža rešetke z ACO DRAIN® kljuko za aretiranje

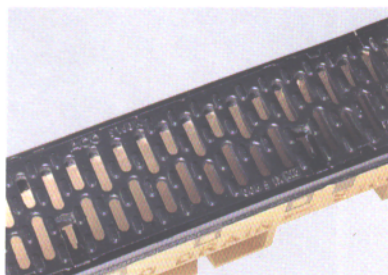

Vzdolžne prečke onemogočajo pretok vode čez rešetko

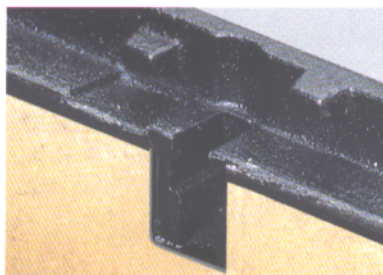

Sidra proti vzdolžnem premikanju in izpadanju rešetak



...enostavna montaža ter zaklep rešetke

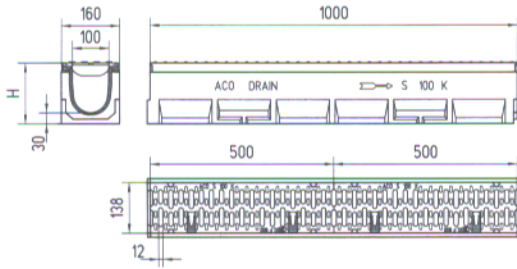

S 100 K, 1.0 m

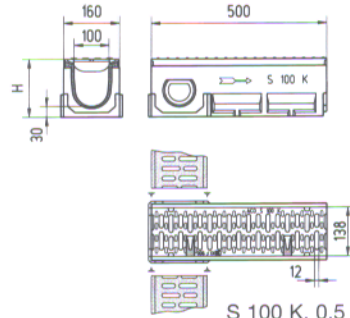

S 100 K, 0.5 M

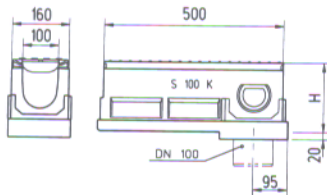

Kanaleta S 100 K, 0.5 m z vgrajenim iztokom DN 100 s tesnilom

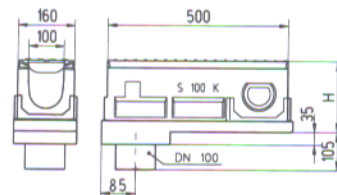

S 100 K, kanaleta z vgrajeno varnostno loputo DN 100

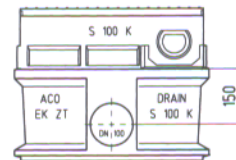
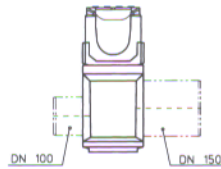
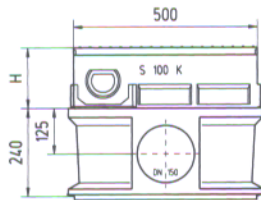

S 100 K, zbiralnik kratka izvedba, spodnji del se lahko uporabi tudi kot vmesni del

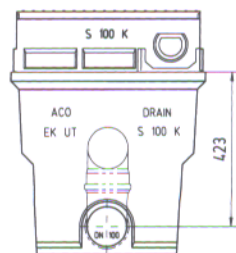
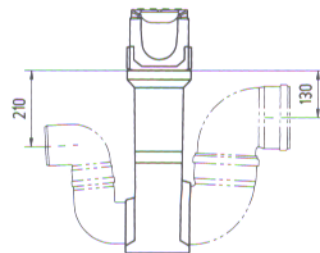
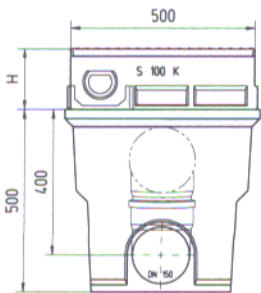

S 100 K, zbiralnik dolga izvedba

NOVO!

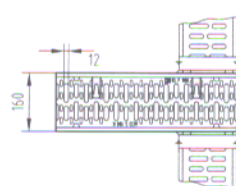
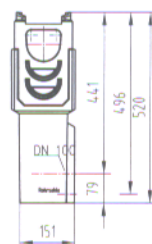
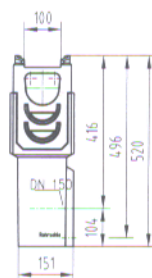
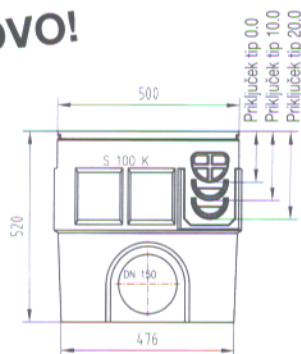

S 100 K, enodelen zbiralnik, z iztokom DN 100 ali DN 150

ACO DRAIN® S 150 K

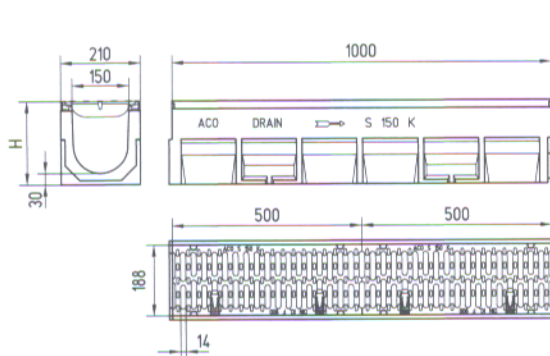

S 150 K, 1.0 m

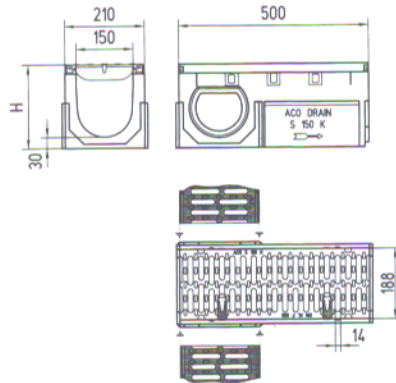

S 150 K, 0.5 m

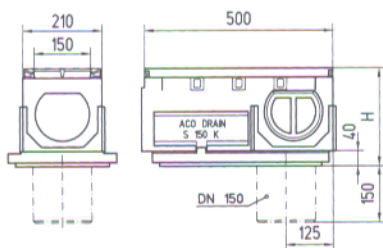

S 150 K, 0.5 m z vgrajenim iztokom DN 150 s tesnilom

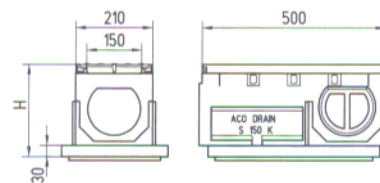

S 150 K, zbiralnik zgornji del



S 150 K, zbiralnik vmesni del

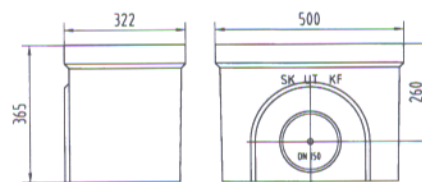

S 150 K, zbiralnik spodnji del, kratka izvedba z iztokom DN 150 ali DN 200

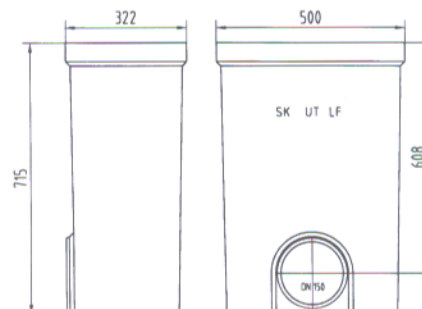

S 150 K, zbiralnik spodnji del, dolga izvedba z iztokom DN 150 ali DN 200

NOVO!

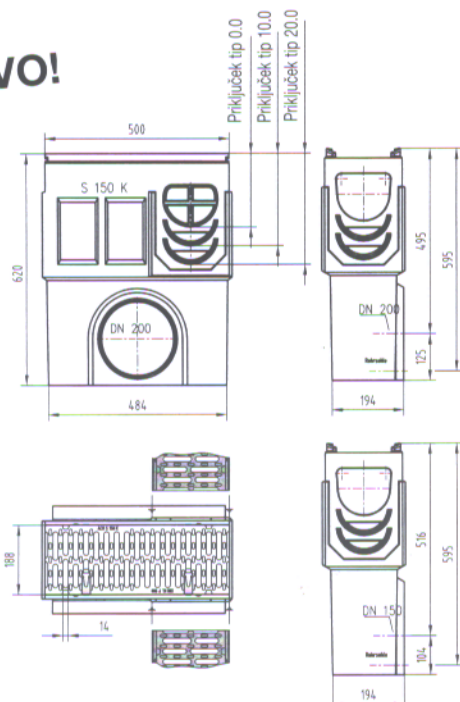

S 150 K enodelen zbiralnik z iztokom DN 150 ali DN 200

ACO DRAIN®

ACO DRAIN® S 200 K

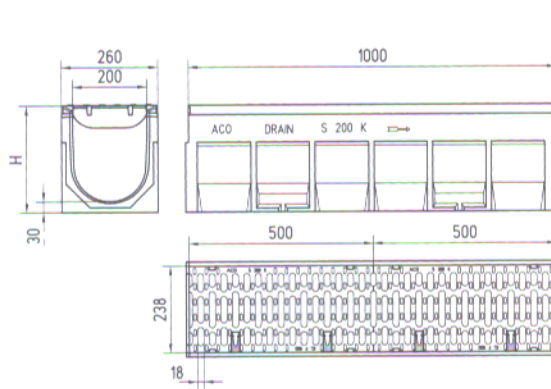

S 200 K, 1.0 m

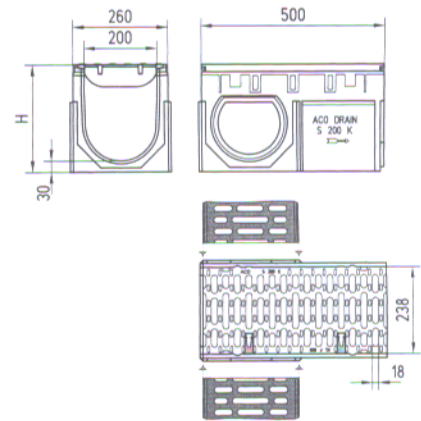

S 200 K, 0.5 m

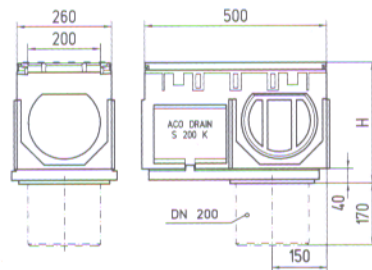

S 200 K, 0.5 m z vgrajenim iztokom DN 200 s tesnilom

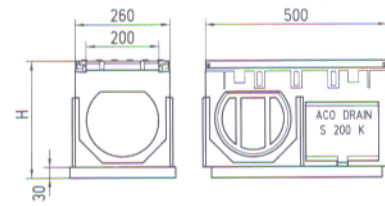

S 200 K, zbiralnik zgornji del



S 200 K, zbiralnik vmesni del

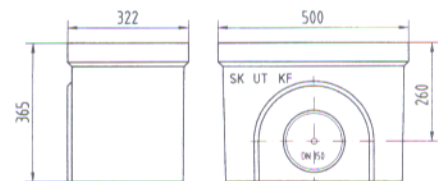

S 200 K, zbiralnik spodnji del, kratka izvedba z iztokom DN 150 ali DN 200

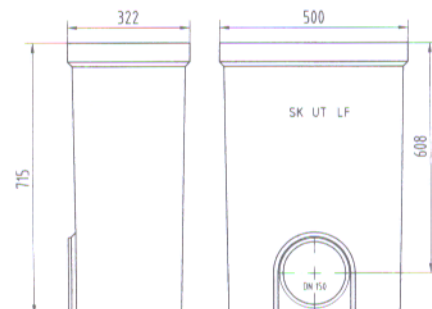

S 200 K, zbiralnik spodnji del, dolga izvedba z iztokom DN 150 ali DN 200

NOVO!

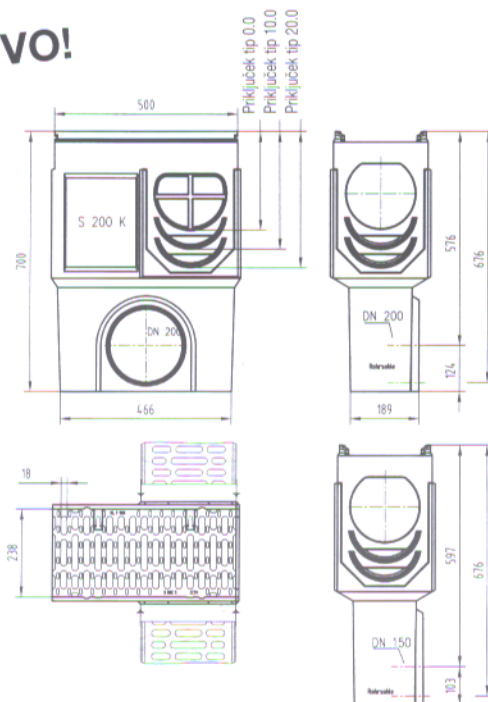

S 200 K enodelen zbiralnik z iztokom DN 150 ali DN 200

Servis za projektante

Za vprašanja, natančne hidravlične izračune, detajle, načrte polaganja in osebne obiske, vam je brezplačno, v vsakem trenutku na voljo tehnična služba na sedežu podjetja.

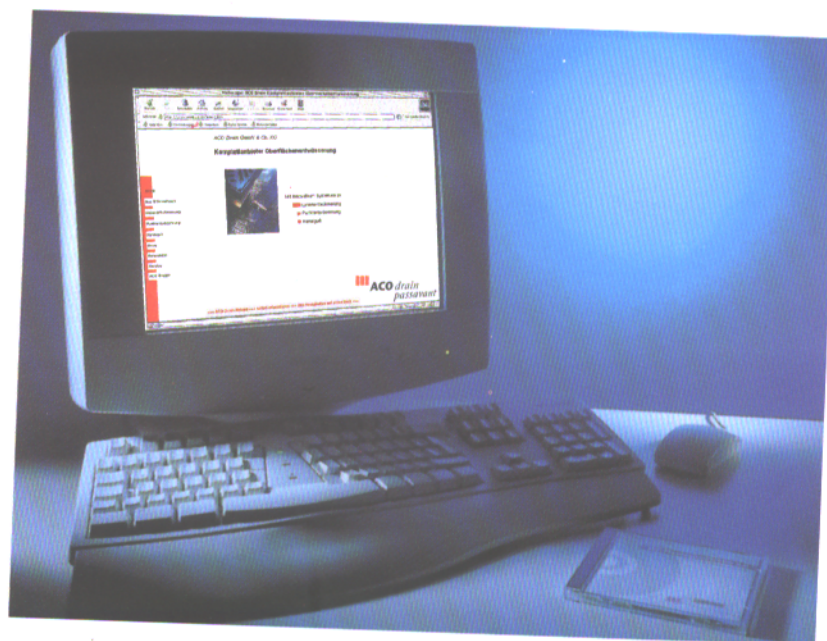

ACO na medmrežju

Naše proizvode in najpomembnejše podatke o njih lahko najdete tudi na našem naslovu www.aco.si, ali pa obiščete spletno stran matičnega podjetja www.acodrain.de.

[http:// www.aco.si](http://www.aco.si)