



The highest quality for maximum safety

ACO drainage systems for tunnels



ACO. The future of drainage.



The ACO system chain creates the drainage solutions needed for tomorrow's environmental conditions

The increase in extreme weather conditions requires more complex approaches to water drainage. ACO provides smart system solutions which work in both directions: they protect people from water – and vice versa. Each ACO product within the ACO system chain sends the water in the right direction, with the aim of being able to recycle it in a way that makes sense both ecologically and economically.

2



collect:
Collect and remove

- Drainage channels
- Road and yard drains
- Top sections
- Manhole covers



clean:
Pre-clean and process

- Separators



hold:
Protect and attenuate

- Protecting watercourses
- Bulk storage



release:
Pump, drain and re-use

- Bulk percolation
- Pumping stations
- Tree grids



The ACO system chain in action



ACO DRAIN® tunnel drainage



ACO shaft manhole cover



ACO large containers as emergency tanks

Every product from ACO supports the ACO system chain

ACO drainage systems for tunnels

As a global market leader in drainage technology, ACO has set itself the challenge of developing special products for tunnel construction and its associated infrastructure. The diverse range of climatic conditions in tunnels and the respective local variations require solutions that are both ecological and economical. ACO tunnel drainage systems include not only standard products such as the Monoblock T drainage channel, but also solutions that are created specifically to suit the needs of particular projects.

In addition to our products, we are proud to offer our experience and service, which allow us to work with you to develop customised solutions. ACO's technical expertise is always on hand when you need it. From the initial designs to commissioning and everything in between, our engineers are here to help you.

The highest quality for maximum safety – ACO drainage systems for tunnels

ACO has the experience and appetite for innovation that are crucial when it comes to implementing solutions for the specific requirements of today's tunnel facilities. Our quality products allow planners and tunnel operators alike to enhance convenience and safety in a whole host of areas. And for those that use the tunnels, this makes our brand promise all the more significant:

The ACO Group. A strong family you can build on.

ACO in tunnels

- Kerb slot channel
in accordance with RABT/ZTV-ING
- Baffle shafts
- Manhole covers and gully tops
- Cable shafts
- Rinsing shafts
- Control shaft covers



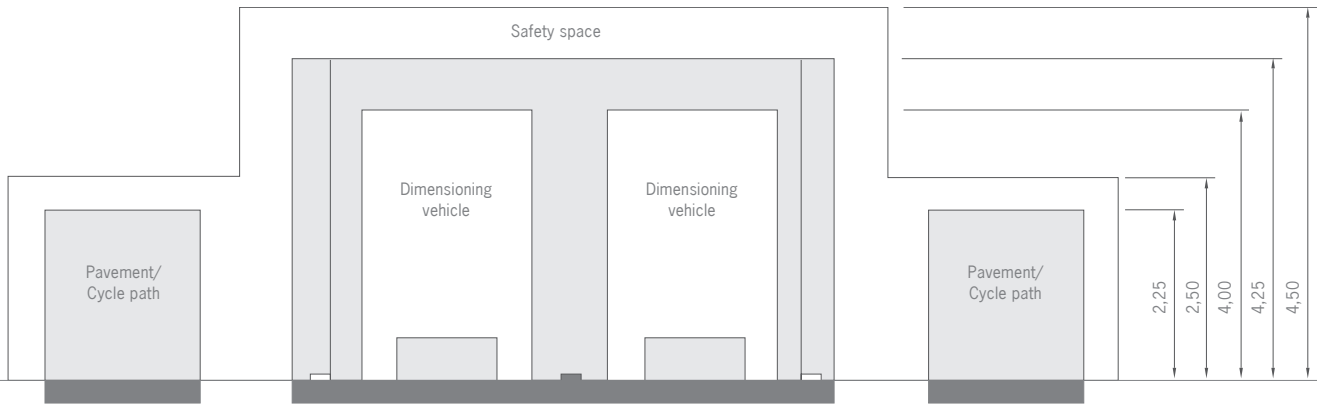

ACO in portal areas

- RABT systems
- Storage basins for fire extinguishing water
- Emergency storage basins
- Pumping and lifting plants
- Manhole covers
- Ramp drainage

ACO for infrastructure

- Manhole covers
- Top sections
- Line drainage
- Point drainage

Extract from the reference list

Country	Tunnel project	Year built	ACO products	Size
CH	Hafnerberg tunnel, Zurich	2003 – 2004	Slot channels Kerbstones	5300 m 5300 m
CH	Aescher tunnel, Zurich	2004 – 2007	Slot channels Kerbstones	8325 m 8325 m
CH	Kirchenwald tunnel, Obwalden	2004 – 2007	Slot channels Kerbstones	6240 m 6240 m
LUX	Grouft tunnel	2007 – 2009	Slot channels	5800 m
DE	Wattkopf tunnel	2008 – 2012	Manhole covers Gully tops Galvanised steel elongated bar grating	18 pces 23 pces 23 m
LUX	Stafelter tunnel	2009 – 2011	RABT systems Tunnel channels	2 pces 1800 m
DE	Einhorn tunnel, Schwäbisch Gmünd	2008 – 2013	Secant shaft manhole cover	251 pces
DE	Bautzen tunnel, OU Bautzen	2011 – 2013	Tunnel channel T 275 V	200 m
DE	Rendsburg channel tunnel	Under construction since 2011	Tunnel channel KD 200	1500 m



ACO in tunnels

Drainage channel system

What properties must a channel possess to meet the requirements of RABT and ZTV-ING? What potential impact does damage have on the intake capacity of the drainage system? What happens to liquids in the drainage channel? How is the safe and unimpeded access to the escape route ensured? The answers to these and other questions can be found in all ACO product systems for tunnel drainage.

When using polymer concrete in tunnels, it is absolutely vital for the material to be classified as "non-flammable". When it comes to tunnel construction, components are required to meet the highest safety requirements in accordance with the European tunnel directive 2004/54/EC and the German guidelines and regulations RABT and ZTV-ING. ACO's special polymer concrete compound conforms to these requirements.

In the event of an accident, particularly where flammable liquids are concerned, leaking hazardous materials are directed along the shortest path from the road surface through the tunnel drainage into the ground and thus separated from the oxygen supply.

The tunnel products are selected according to the needs and circumstances of the project, offering maximum scope in terms of planning and design.

Clear benefits thanks to the design and materials

The extreme resistance and rigidity of the polymer-concrete channel body mean its long-term service life is guaranteed. Quartz fillers and reaction resin make this material waterproof, meaning it is ideal for use in civil engineering projects and tunnel construction.

Thanks to its resistance to both frost and de-icing salt, ACO polymer concrete is extremely low maintenance. The low degree of roughness means that any dirt deposits can be washed away with ease.

The rigidity of the polymer concrete and the channel structure make it possible to create a thinner wall with a maximum flow cross-section. Compared to concrete kerb slot channels, the ACO tunnel channel offers space savings of up to 25%, leaving more room for factors such as cable laying in the emergency walkway.



When it comes to large area drainage, the unique single case construction of the ACO DRAIN® Monoblock kerb slot channel T 275 V guarantees the highest levels of safety and stability. Channels and grating are made in a cast from polymer concrete. Thanks to the monolithic design, the channel body remains stable and keeps its shape even under extreme loads.



Proven material with outstanding properties:

The channel body made of ACO polymer concrete

The special composition of the materials and latest production technologies are what give ACO polymer concrete its outstanding profile:

- Flexural strength: > 22 N/mm²**
- Compressive strength: > 90 N/mm²**
- Modulus of elasticity: approx. 25 kN/mm²**
- Density: 2.1 – 2.3 g/cm³**
- Water penetration depth: 0 mm**
- Resistance to chemicals: high**
- Surface roughness: approx. 25 µm**

At a similar density, ACO DRAIN® channel elements are much stronger and lighter than comparable concrete products. The low weight of the prefabricated parts makes it easier both to handle and install, and even reduces costs. Polymer concrete is waterproof and offers no potential for damage due to frost. The smooth surface allows water and dirt particles to simply run off while also making it easy to clean. What's more, polymer concrete needs no additional coatings to make it resistant to aggressive media, and can be used in the long term for many different purposes under extreme conditions.

The special ACO polymer concrete compound for tunnel applications meets all classification requirements for a non-flammable building material.

ACO's special polymer concrete compound is the first polymer concrete that meets the A2-s1, d0 "non-flammable" fire class in accordance with DIN EN 13501-1.

Cast iron material

The cast-iron products in the ACO range are manufactured in the ACO Group's own foundries. The products are subject to stringent quality checks and undergo independent quality testing by the Kaiserslautern Material Testing Office (MPA), Germany, in accordance with the applicable standards.

Due to the water absorption of the material and the local climatic conditions, DIN EN 1433 and DIN 19580 specify the need for the highest quality grade of "W" for concrete. As the material properties of polymer concrete are simply outstanding, no special requirements are made in this regard.

The raw materials found in ACO polymer concrete are subject to strict specifications and continuous quality controls. Further to the in-house quality testing according to DIN EN 1433, product checks and independent quality testing are also carried out by Kiwa Deutschland. In addition, the Germany-based Hansa-Nord-Labor (Pinneberg) and the MPA materials testing institute in Lübeck perform type testing as per DIN EN 1433.

Properties of various materials for drainage channels

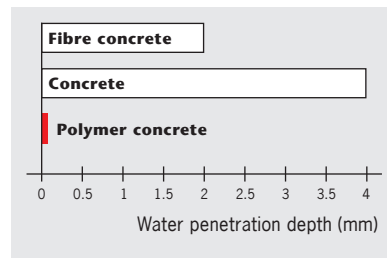

Water penetration depth (DIN 4281) after 72 hours

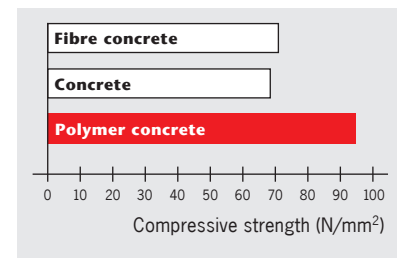

Compressive strengths

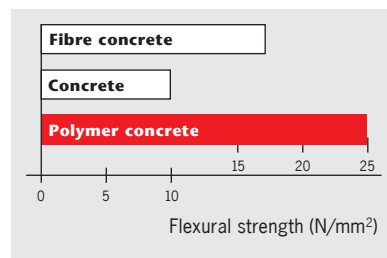

Flexural strengths

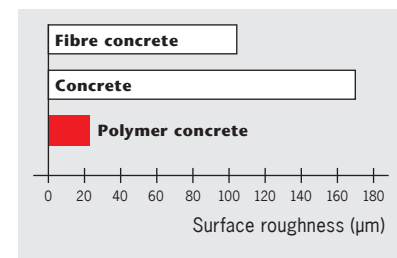

Average surface roughness levels

ACO polymer concrete exceeds the exposure classes required for tunnels in accordance with DIN EN 206-1 and DIN 1045-2.

Flake graphite cast iron EN-GJL grey cast iron in accordance with DIN EN 1561	Spheroidal graphite cast iron EN-GJS spheroidal graphite cast iron in accordance with DIN EN 1563
<ul style="list-style-type: none"> ■ High corrosion resistance to waste water, de-icing agents and other environmental influences ■ High compressive strength: 600 to 1080 N/mm² ■ Ideal attenuation properties ■ Tensile strength: 100 to 350 N/mm² ■ Low breakage tension, low elastic distortion 	<ul style="list-style-type: none"> ■ High corrosion resistance to waste water, de-icing agents and other environmental influences ■ High compressive strength: 700 to 1150 N/mm² ■ Moderate attenuation properties ■ High tensile strength: 350 to 900 N/mm² ■ High breakage tension, high elastic distortion
<p>These properties make grey cast iron the material of choice in the frames for manhole covers and gully tops.</p>	<p>These properties make spheroidal graphite cast iron the ideal material for highly durable covers and gratings for low-weight manhole covers and gully tops.</p>

ACO DRAIN® Monoblock kerb slot channel T 275 V

Design

The ACO tunnel channel has been developed especially for use in tunnels. The development not only reflects the new requirements that have been placed on tunnel channels as a result of valid standards and regulations, it illustrates the overall requirements profile of planners, construction contractors and operators. The multifunctional system, which demonstrates powerful performance across all applications, ensures tight installation programs can be met. The sophisticated design ensures a low net weight with a high load capacity of the components – with clear benefits to the fitters.



Flow cross-section

The ACO Monoblock kerb slot channel T 275 V is formed to correspond to the innovative V-shaped cross section typical of ACO. The advantages compared to a standard circular cross-section lie in the details:

- improved drainage performance
- greater self-cleaning capacity
- lower cost of cleaning and maintenance

Slot for blank pipe for LED control devices

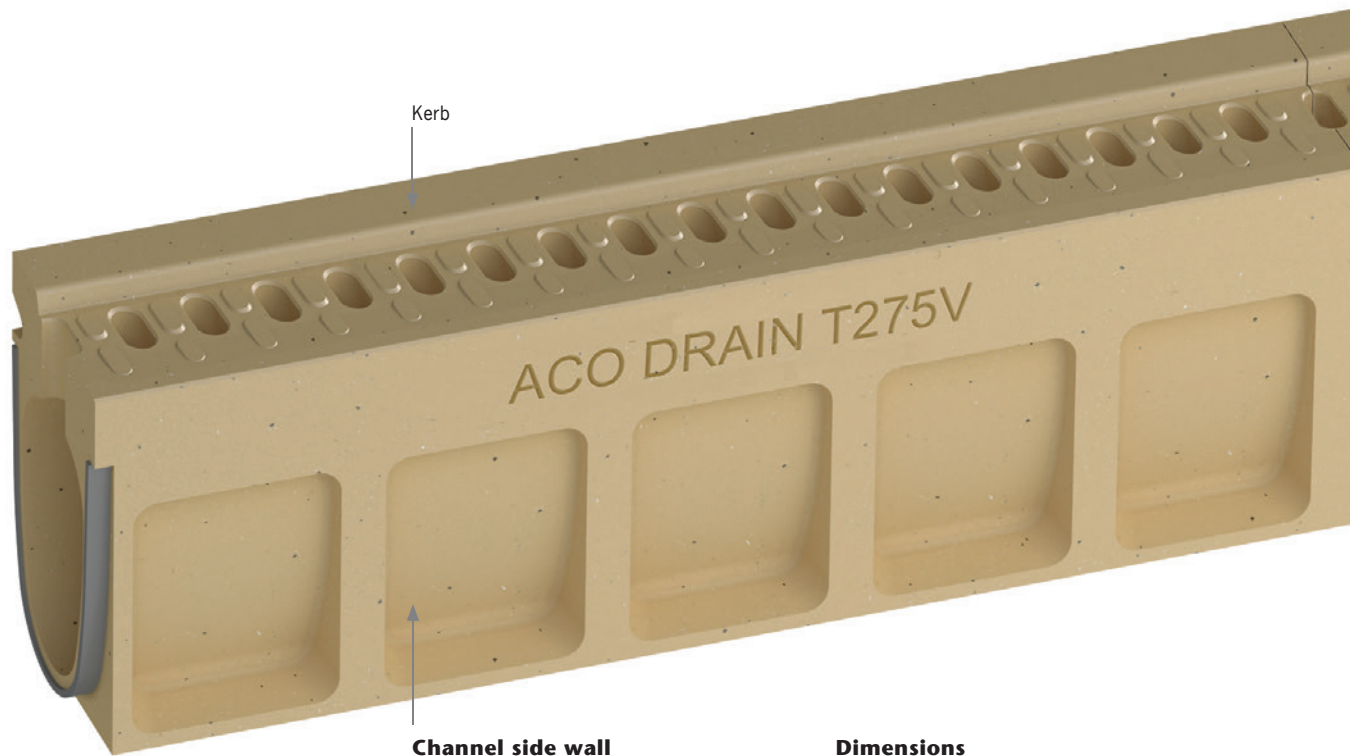

Kerb

Channel side wall

The new side wall structure and the intelligent distribution of material result in increased load-bearing ability and overall stability. The undercut pockets not only save on material and thereby weight, they also serve to improve anchoring to the adjacent concrete filling in the area of the emergency walkway.

Dimensions

The ACO DRAIN® tunnel channel is adapted to the known dimensions of the flow cross-section. Yet while the component height is the same, the depth of the ACO Monoblock T 257 V is 25% narrower than reinforced concrete products. When it comes to planning the facility, this extra space in the emergency walkway is something that should not be overlooked.



ACO tunnel drainage video clip



Outlet/inlet end

The outlet/inlet side of the ACO Monoblock T is fitted with a seal at the factory. Installation from above against the gradient guarantees components are securely sealed, as well as ensuring precision and saving costs during laying.

The lip seal attached at the factory produces a liquid-tight butt joint, which is effective and provides scope for design in the planning and execution stages where there are horizontal radii and changes of gradient.

Seal

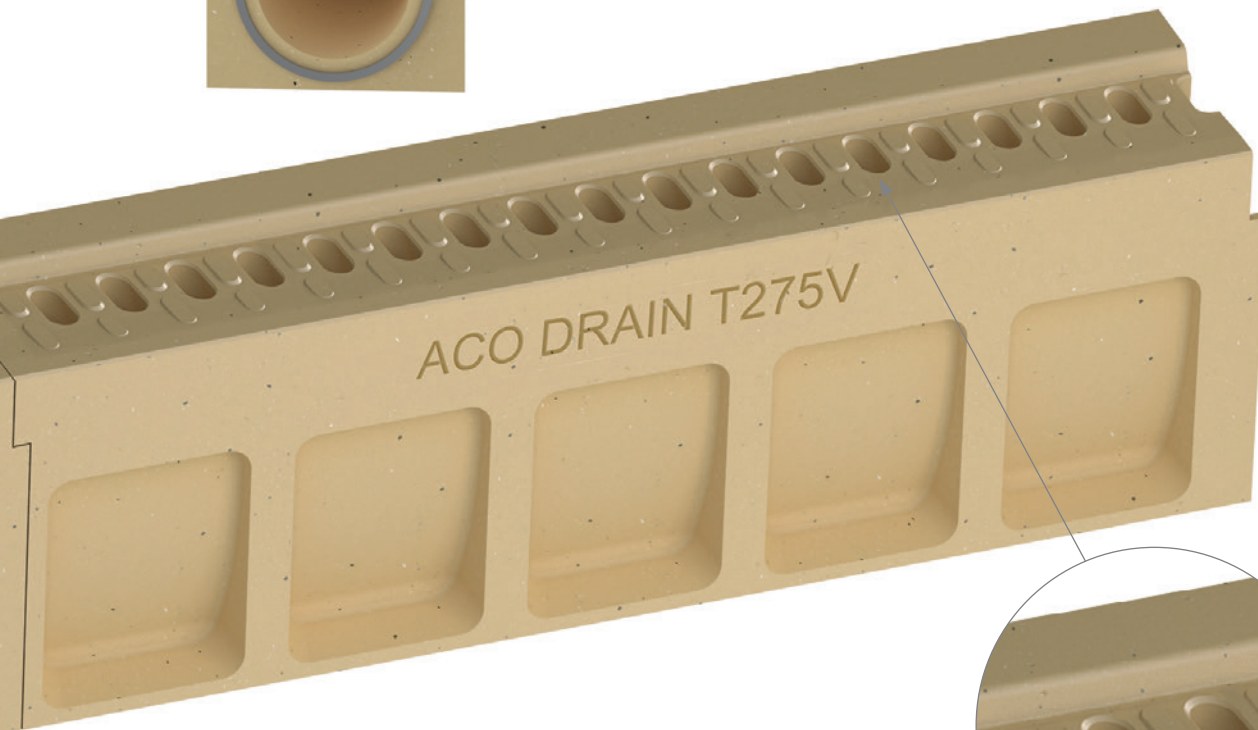

ACO DRAIN T275V

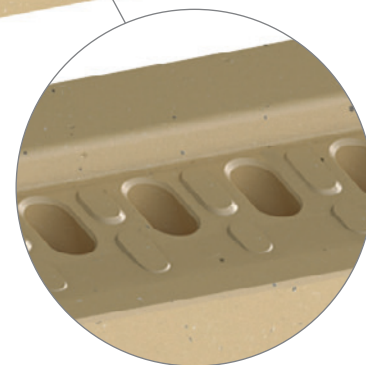

Channel head

The main feature of the ACO Monoblock kerb slot channel T 275 V is the channel head. This has several individual slots which are separated by intermediate dividers. In order to direct the liquid in a targeted fashion and to increase the roughness of the channel surface, there is napping on the intermediate dividers. There are numerous advantages to forming the inlet openings in this way:

- Safety for wheelchair users when passing over and crossing the channel to reach the emergency walkway, no sticking of the wheels thanks to short slot apertures
- Safety for cyclists and motorcyclists, particularly in inner-city tunnels
- Visual separation of the road and the emergency walkway through the surface structure
- Integrated rumble strips increase safety through vibrations and noises when driven over
- Smaller, flushable objects can be taken up and accepted whereas hub caps will not become wedged in the channel

In accordance with the requirements of the German guidelines for equipping and operating road tunnels (RABT), the ACO Monoblock T 275 V can be supplied with kerb heights of 3 and 7 cm or without a kerb. According to requirements, it can also be supplied with a closed channel head.

There is another feature on the kerb side of the channel head. Here, there is a slot for housing ductwork (DN 40) enabling LED control lines to be installed.

Accessories

Baffle shaft

The baffle shaft is the transition element and acts as a partition. It separates the closed drainage system (the longitudinal drainage guide) from the tunnel channel open drainage system. The integrated baffle functions like a siphon. A minimum amount of liquid in the shaft base and the protruding baffle act as a firewall against the passage of flame along the longitudinal drainage guide and as a foul air trap. Beneath the baffle shaft, a run-off rate of 100 l/s is guaranteed. The connection to the longitudinal drainage guide is secured with a suitable pipe connection cross-section and a lip labyrinth seal. The shaft is made accessible for inspection by two manhole covers on the upper side of the shaft.

In accordance with regulations, the baffle shaft manhole cover on the outlet side in relation to the longitudinal drainage guide is designed as a seal. The integrated inspection covers made of cast iron form part of the surface structure of the Monoblock T and therefore ensure a uniform overall appearance. With two fasteners per cover, it is guaranteed to be watertight and is secured against ejection.

In the inlet area of the baffle shaft, the tunnel channel drains over a removable sludge bucket. In the case of an accident, the space between the sludge bucket and baffle on the inlet side has been designed as an emergency overflow. This space ensures a run-off rate of at least 100 l/s in accordance with the regulation.



Baffle shaft

Inspection element

The inspection element forms the start of the channel train. The 1 m element is available in the necessary tunnel cross-sections.

The main feature is the integrated inspection cover made of cast iron. With the reproduction of the kerb in the frame and the cover, as well as the Monoblock T surface structure, the overall appearance is uniform. The cover is secured by two fasteners.

Connecting element

Connecting elements are used when a siphon bend is included in the connecting line to the longitudinal drainage guide. The connecting element provides the pipeline connection with a corresponding seal as an outlet. The size of the seal can be adapted to the project requirements.

Additional features of the connecting elements correspond to those of the inspection element. The whole system which includes the comprising connecting element and connecting line as a siphon, forms a system alternative to the baffle shaft in accordance with RABT and ZTV-ING (additional technical terms of contract and guidelines for civil engineering works in Germany).

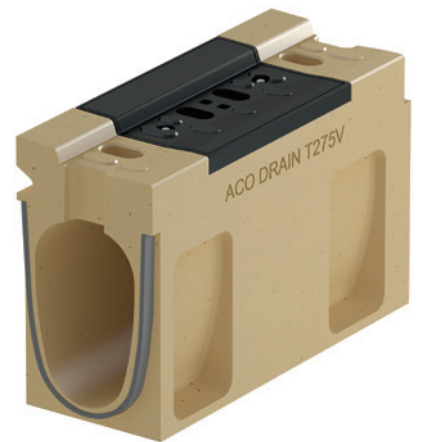

Inspection element



Connecting element

Installation recommendations

Installation situation for the ACO DRAIN® Monoblock kerb slot channel T 275 V in a tunnel, load class D 400

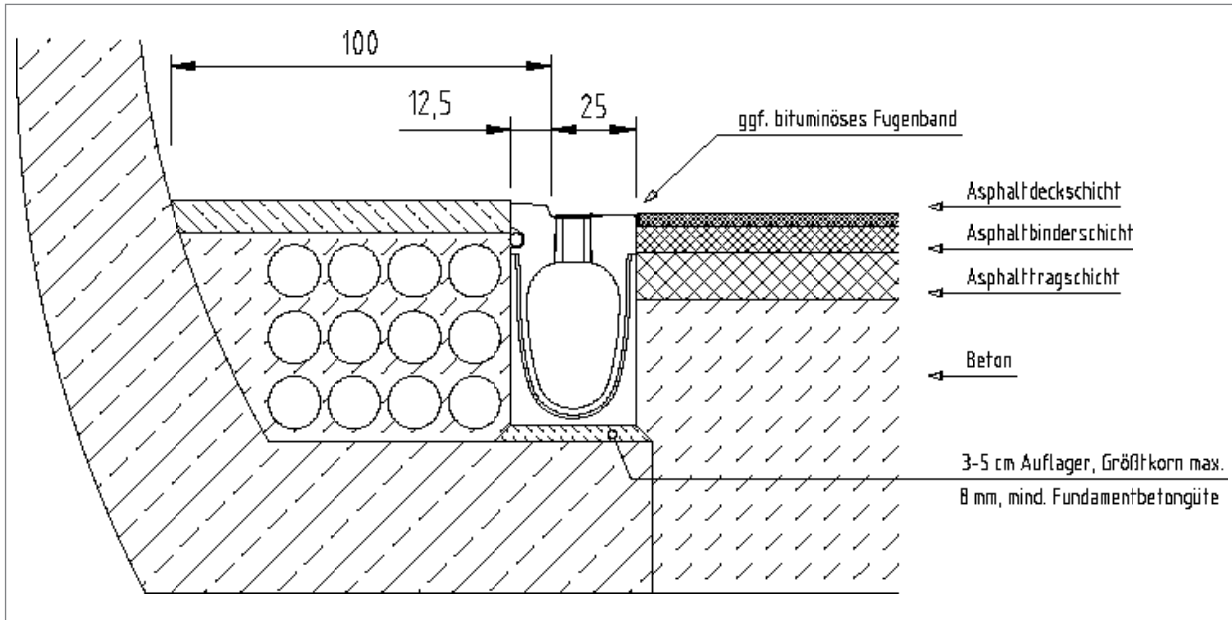

Dimensional drawings of the channel body with inspection and connecting elements

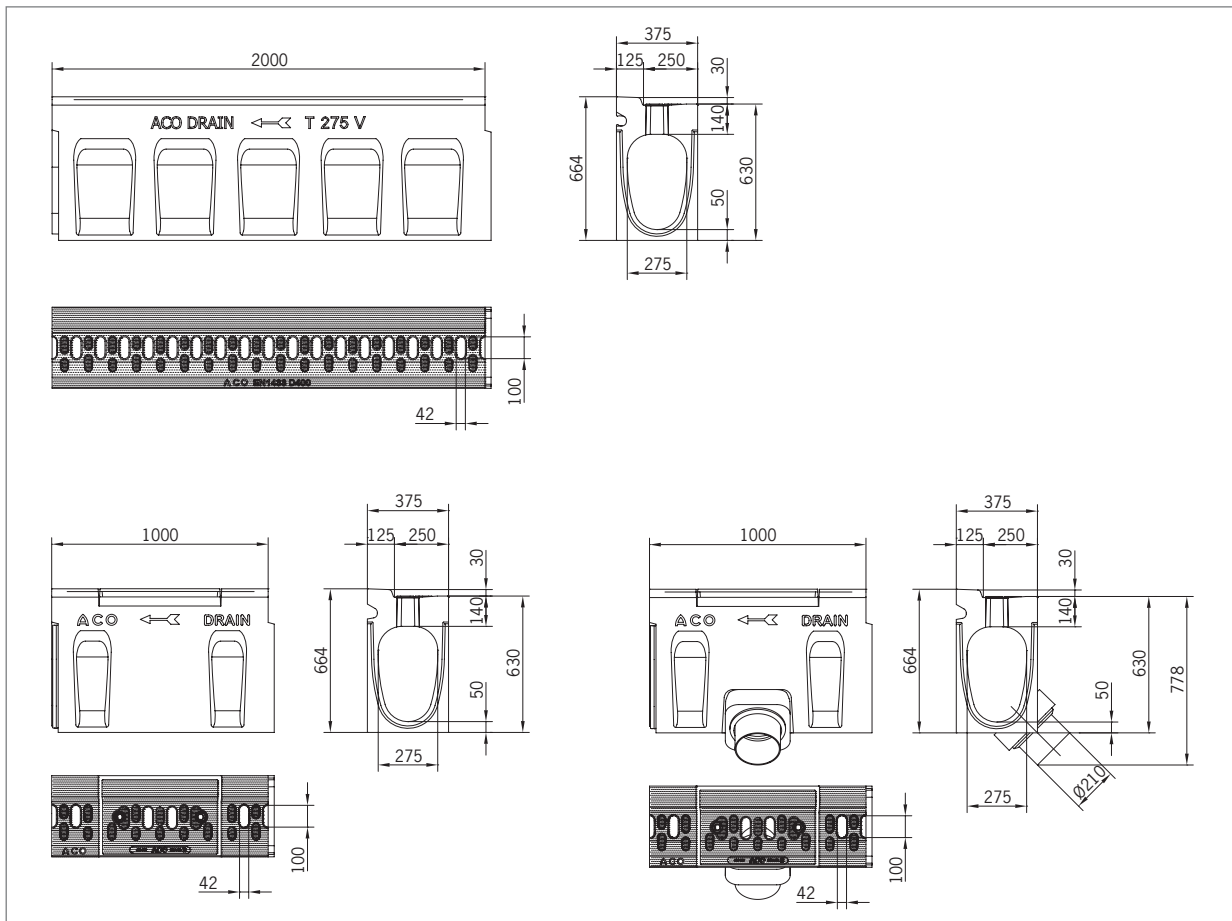

ACO in tunnels

The Bautzen tunnel is built upon the ACO DRAIN® Monoblock kerb slot channel T 275 V



A key feature of the west bypass in the Saxony town of Bautzen is the Bautzen tunnel, which allows the new B 96 road to run under the B 6. Part of the tunnel's configuration involved installing a drainage system that would also be suitable for emergency situations. The ACO DRAIN® Monoblock kerb slot channel T 275 V meets the requirements of the European tunnel directive 2004/54/EC, as well as the German guidelines and regulations RABT and ZTV-ING, and was put out for tender. At just 483 kg, the low weight of the prefabricated parts made the handling and installation processes considerably easier. Thanks to its 2-metre length, it was possible to transport the channel elements into the tight spaces with ease using a small lifting device. From there, the installation process could take place with speed and precision. The concept of installing from above offers a significantly greater laying rate than other tunnel channel systems with socket connections.



Simple to transport and easy to install



Building unit for Monoblock kerb slot channel T 275 V with inspection element and connecting element

Unlike conventional slot channels, the ACO DRAIN® Monoblock kerb slot channel T 275 V does not have a continuous inlet slot. Instead, the channel head is fitted with several individual slots. What's more, the roughness of the channel surface is increased by blobs on the intermediate dividers. This offers added safety not only for wheelchair users when passing over and crossing the channel to reach the emergency walkway, but also for cyclists and motorcyclists, particularly in inner-city tunnels. The special arrangement of the individual slots also prevents larger objects such as hubcaps from becoming wedged into them, but still accommodates smaller objects that can simply be washed away. The structured surface is also intended to create a visual separation between the road and emergency walkway. Safety is increased further still thanks to the noises and vibrations produced when driven over.



Tunnel channel and foundations parted off on the roadside with a back support on one side



Integrated groove for installing blank pipes (DN 40) for LED control equipment



Connecting element with siphon pipe to the control shaft and connection to the longitudinal drainage guide

ACO in tunnels

The Rendsburg channel tunnel is brought up-to-date with an individual solution

The 50-year-old Rendsburg channel tunnel forms part of the B 77 and crosses under the Kiel Canal. This project involved renovation and retrofitting work the tunnel in accordance with guidelines and regulations, and also featured some unusual characteristics relating to the structure's stability and restricted space.

When it came to updating the Rendsburg channel tunnel, the project development process concluded that a special tunnel drainage solution was required. As a result, ACO constructed the ACO DRAIN® tunnel channel KD 200, a monolithic polymer concrete kerb which doubles up as a drainage channel. This channel meets the highest safety requirements for tunnel construction.

Its additional optimisation of the channel cross-section has improved the stability of the side wall, outflow performance and self-cleaning, while also offering

maximum drainage performance for the highly specialised project specifications. The monolithic structure of the channel (load class D 400 in accordance with DIN EN 1433), which has no adhesive joints, features a flow cross-section of 215 cm²/m. The lateral inlet openings, requested specifically for the project, ensure that 1.5 times the required amount of emergency liquid is collected.

Despite the low installation depth, the compact design of the ACO KD 200 has enabled a 30 percent increase in the intended reach length – from 16.7 m to 25 m. The installation rate was also increased thanks to the concept of installing from above, and by producing a 1-metre element.

Accessories such as the baffle shaft and maintenance elements complement this special solution for the Rendsburg channel tunnel perfectly.

Expansion joint element

As tunnels are subject to significant modifications, the seals between individual channel elements must conform to particular requirements. To connect channel bodies so that they can be moved and yet maintain their liquid-tight properties, ACO developed the surface-watertight expansion joint element. This consists of a stainless steel element with a dual-body design, to which the tunnel channel is adapted according to the project requirements at the construction site. The tunnel channel is then tightly connected to the expansion element. Despite significant movements transversely to the channel axis, the structure remains liquid-tight between the channel bodies and its neighbouring component. For the Rendsburg channel tunnel, the predefined range of movement is between +/-7mm in the tunnel's block joints. The channel is processed to fit to the expansion element by means of cutting carried out on site and is then sealed, thus eliminating the need for any costly or time-consuming pre-assembly.

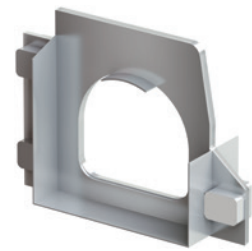
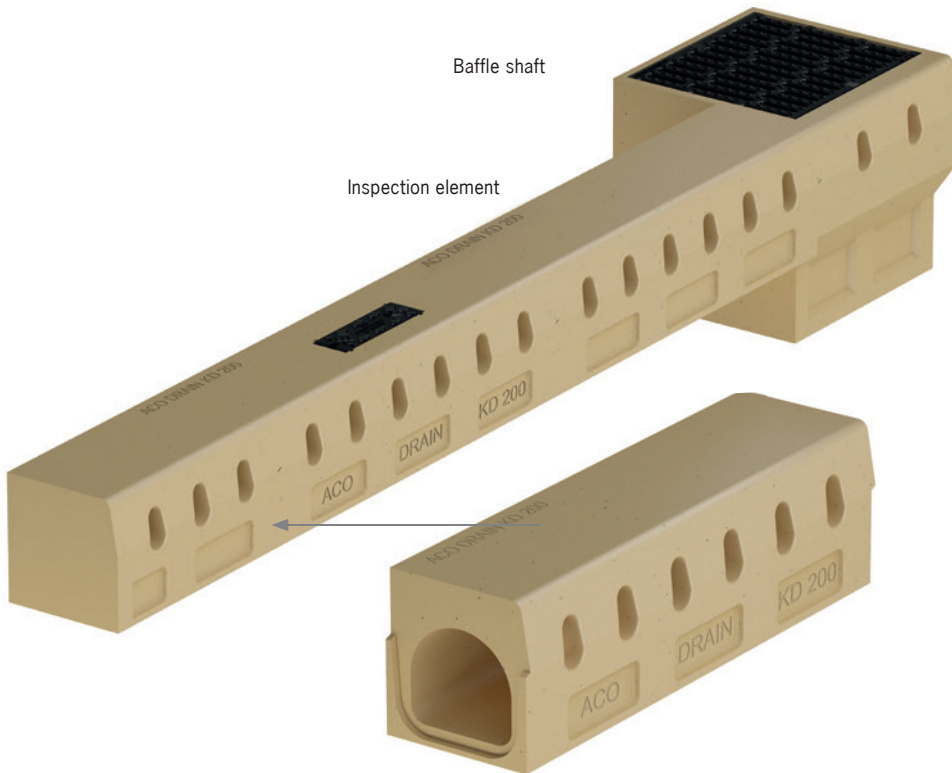

Expansion joint element for ACO KD 200

The ACO DRAIN® tunnel drainage KD 200 is a monolithic polymer concrete kerb which doubles up as a drainage channel



The baffle shaft as a special, project-specific solution in accordance with ZTV-ING and RABT

The original design involved connecting a channel drain to the pipe system with a siphon. The technical parameters required within the tunnel meant that this had to be changed, and a new solution was needed that not only suited the project conditions, but also complied with the relevant regulations. With these requirements in mind, ACO developed a special drainage shaft for the Rendsburg channel tunnel.



Baffle wall shafts ready to install

The space-saving and easy-to-clean design of the ACO baffle chute is particularly attractive given the limited space in the tunnel and the huge encroachment into the building substance that the siphon pipe solution would bring. The baffle wall shaft has a flexible, stainless-steel baffle wall that forms an inflow chamber and a sealed outflow chamber. Above this, the revision opening is covered by a cast iron grating with a Drainlock catch. The baffle wall shaft is tested to load class D 400.

ACO in portal areas

A large-scale tank system made from prefabricated reinforced concrete components

Multi-part tank systems are always used where large volumes of rain or grey water need to be treated or retained. The ACO large-scale tank system was developed using the latest, most advanced technology. The container design along with the configuration and layout of the entire system is implemented according to project requirements. This includes designs for the storage, temporary storage and drainage of liquid media. The tanks consist of multiple reinforced concrete rectangles (concrete quality at least C 35/C 45 DIN 1045), which are assembled at the construction site by the ACO installation team. The cover plate is already pre-assembled at the factory.

A unique feature of the ACO large-scale tank system is the innovative clamping system that ensures rapid mounting. In addition as the segments have a special seal all the way around, there is no need for tedious and costly grouting of the components. Once installed, the tank is immediately sealed and watertight up to the top edge of the cover plate, meaning it can be filled with water and a tightness test can be performed right away.

Thanks to the new technologies, installation times and the associated costs are significantly reduced. Particularly where ground water has to be drawn off, rapid installation is valuable.

Benefits

- Very short fitting time thanks to innovative clamping system, which minimises construction time
- Ability to carry out a tightness test/fill the tank immediately after mounting, as there are no mortar joints to be filled
- Saves costs when ground water has to be drained off
- Variable width and height
- Static dimensioning to suit specific applications
- High quality defined by pre-fabricated concrete components from the factory



Installation example: 100,000 l fire extinguishing water tank, Mainz University, Germany



ACO large containers as fire extinguishing water tanks

Applications

- Storage basins for fire extinguishing water
- Emergency tanks in accordance with RABT and ZTV-ING
- Light oil separator systems in accordance with RiStWag (German Guidelines for Road Engineering Measures on Roads in Areas of Water Extraction)
- Large separator
- Sedimentation systems
- Surface water retention

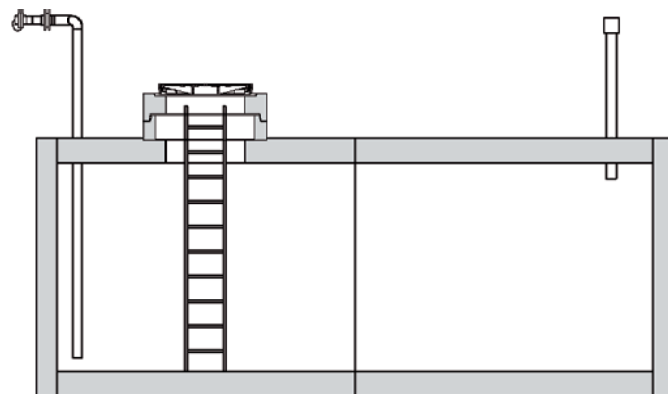

A distinction is made between dependent (generally drinking water networks) and independent fire extinguishing water supplies. Fire extinguishing water tanks represent a type of independent supply.

They are generally installed where an adequate extinguishing water supply via the existing drinking water network cannot be guaranteed. They are designed in accordance with DIN 14230.

RABT system – emergency storage basins

When it comes to refurbishing and retrofitting tunnels and tunnel constructions, space-saving, fast and high quality solutions are in real demand. The container design along with the configuration and layout of the entire system is implemented according to project requirements. This includes designs for the storage, temporary storage and drainage of liquid media.

It is possible to combine the RABT system and the fire extinguishing water tank. Alongside the conventional testing method of filling with water, it is also possible to use compressed air to check tightness in large-scale tank systems. This method delivers quick results with little outlay required for provisions.



Use compressed air to check tightness



ACO large containers as emergency tanks with fire-extinguisher containers at the Stafelter tunnel

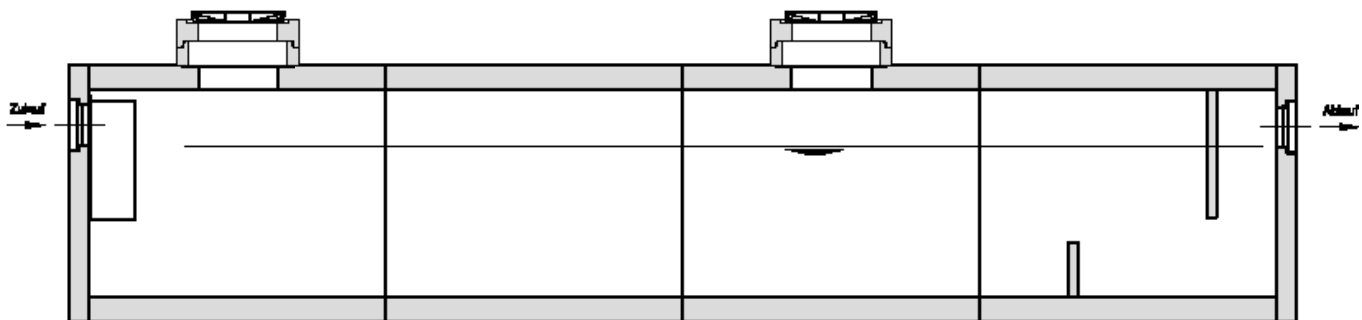

Example project:

The Stafelter tunnel building project,
Luxembourg, north aspect
Component: NS 100 RABT system
Clear width: 12.0 x 3.7 x 2.1 m
(basic tank L x W x H)

Sludge trap volume: 10,000 l
Light oil storage basin volume: 30,000 l
Fire extinguishing water tank volume: 72,000 l
Installation time: 4 hours

ACO for infrastructure

Manhole covers for shafts, maintenance access points and tunnel emergency exits

Thanks to the materials used in its construction and the various design options, the flexible Secant cover system is suitable for use in many fields of application.

The Servokat shaft manhole covers with opening aids are the perfect solution for servicing and inspection purposes at frequent intervals. In urban areas, it is already put to good use as a tunnel emergency exit. By fulfilling all safety requirements and being so easy to use, the Servokat shaft manhole cover is the perfect way to cover tunnel emergency exits.



ACO Secant manhole covers used as inspection covers in Wattkopf tunnel

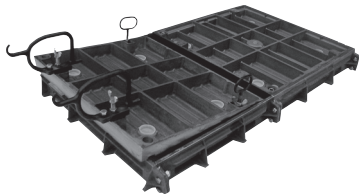

ACO Secant shaft manhole cover



Open shaft manhole cover

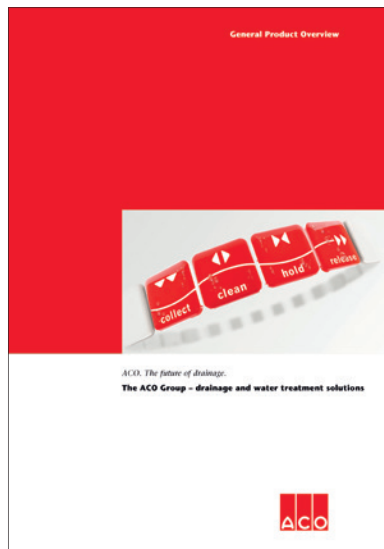

The "General Product Overview" brochure can be requested from vertrieb-kg@aco.com or www.aco.com

Manhole covers and gully tops – ACO multi-top systems

Operational safety, durability and efficiency are the main requirements for the transport infrastructure of tomorrow. Multi-top products offer optimal solutions to well-known problems relating to weight, handling, wear and mortar joints. With sophisticated product features and a surface design that is both hydraulically and visually appealing in terms of its application, ACO offers manhole covers and gully tops of the highest technical quality.



ACO gully tops and multi-top manhole covers



Online information, installation video and brochure downloads

Road gullies – ACO Combipoint PP system

The flexibility is new, but the material is as light and robust as ever. For the first time, the ACO Combipoint PP includes a plastic road gullies which can be twisted, telescoped, shortened and set at an angle. Thanks to their innovative modular construction, the gully bodies can be made a perfect fit to the local topography. The drainage modules, made out of highly resistant PP, only weigh 2.5 to 2.8 kg. The system is completed with gully tops in class C 250/ D 400. You can remove the need for mortar joints, which bring expensive renovation work in their wake. The load separation is taken care of by the telescopic principle within the drain components.

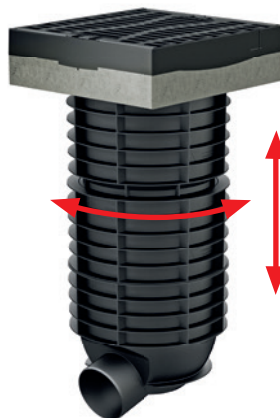

ACO Combipoint road gully with gully top



Online information, installation video and brochure downloads

Drainage channels on motorways and at tunnel entrances –

ACO DRAIN® Monoblock system

Guarantees the highest level of stability, particularly in the areas of transverse and longitudinal drainage on motorways and highways. Even container terminals and airports are ideal places to install ACO DRAIN® Monoblock channels. All these applications have one thing in common: high dynamic forces. For example, these are created by being driven over by around 120,000 vehicles per day. Whether at the high speeds found on Formula 1 racetracks and motorways, or in places where heavy loads are being moved, Monoblock can withstand it all.



ACO DRAIN® Monoblock RD 200 V for transverse and longitudinal drainage on motorways and highways



Online information and brochure download



**ACO Severin Ahlmann
GmbH & Co. KG**

P. O. Box 320
24755 Rendsburg
Am Ahlmannkai
24782 Búdelsdorf
Phone +49 (0)4331 354-0
Fax +49 (0)4331 354-223

vertrieb-kg@aco.com
www.aco.com